



borg & overström B3

Dispense options

Chilled & Ambient
Chilled, Ambient & Hot
Chilled, Ambient & Sparkling
Chilled, Hot & Sparkling



Chilled



Ambient



Hot



Sparkling

Contents

2	Model Overview
	2 Introduction
	3 Controls
4	Components
	4 Major Components
5	Operation
	5 Water Connection & Operation
	7 CO2 Bottle Installation
	8 Functions & Controls
9	Maintenance
	9 Isolation & Removal
	10 Sanitisation Guide
	11 Leak Detection
	12 Emptying the Carbonation Tank
13	Advanced Troubleshooting
18	Exploded Diagrams
24	Technical Information
	24 Electrical Circuit Diagrams
	28 Flow Diagrams

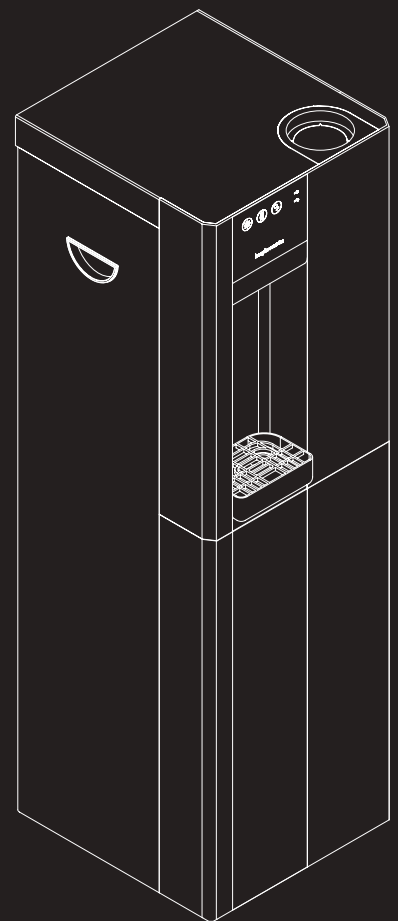



Model Overview

Introduction

A range of compact water dispensers, available in the following operational types:

Countertop:

- Direct Chill Chilled & Ambient
- Direct Chill Chilled, Ambient & Hot

Floorstanding:

- Direct Chill Chilled & Ambient
- Direct Chill Chilled, Ambient & Hot
- Direct Chill Chilled, Ambient & Sparkling
- Direct Chill Chilled, Hot & Sparkling

The B3 model is available in three colours.

All Models

All models are self-contained machines with robust steel chassis and attractively injection moulded plastic front and top panels. For floorstanding models there is sufficient space internally for most filters. For countertop models any filters would need to be fitted externally.

An IEC Power Lead is supplied for connection to the IEC socket found on the rear of all models (An additional Schuko type is supplied for the European market).

Chilled

Water is fed into the insulated cold tank under mains pressure. We strongly recommend a Pressure Reducing Valve is fitted to all supplies to regulate the pressure to 3.5 bar/355 KPat. The cold tank is chilled via the evaporation coil of the capillary controlled refrigeration compression system. The cold temperature is thermostatically controlled via the adjustment screw on the cold thermostat. This is factory set and is not necessary to adjust in most cases (see Controls).

Ambient

Water bypasses the cold tank for the ambient dispense.

Sparkling

Water is chilled as it passes through the Direct Chill coil. It is pumped under pressure into the carbonator which is fitted within the Direct Chill coil. The carbonator is also level controlled. The Deep Sparkle effect occurs through saturation with CO₂.

All models also incorporate a leak detection device within the unit which disables the dispense function until rectified.

Hot

Hot water is provided by hot water tank with an integrated heater element. The water is supplied directly into the tank under the pressure as connected into the back of the unit. The water fills the tank and hot water is dispensed by displacement. The water flow is controlled by a solenoid.

Direct Chill

Borg & Overström Direct Chill utilises innovative technology to chill water instantly. We recommend this system for more demanding environments because of its optimum dispense performance and unrivalled hygienic qualities. Superior to the gravity fed Reservoir system, Direct Chill technology chills water on demand for the ultimate drinking experience.

Controls

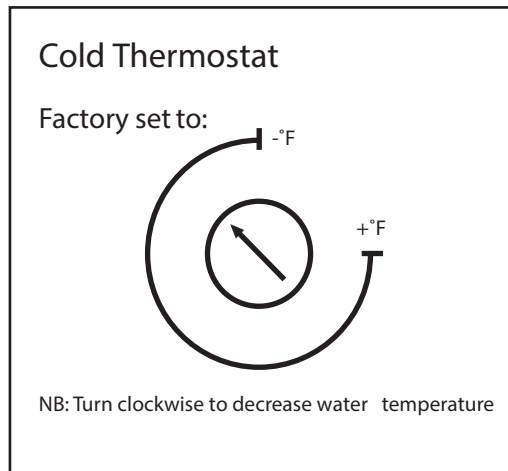

Chilled

Chilled On/Off Switch: at upper rear of machine, switches cooling operation on/off.*

Cold Thermostat: at rear of machine.

Chilled Button: Press to dispense cold water.

Chilled LED: Indicates chilling application is switched on.

10A Fuse: On rear of machine, integral with IEC socket.

*All sparkling variants incorporate an auto-fill system

Ambient

Ambient Button: Press to dispense ambient water.

Sparkling

Carbonation On/Off switch: Switches sparkling operation on/off.

Sparkling Button: Press to dispense sparkling water.

Sparkling LED: Indicates sparkling application is switched on.

Hot

Hot On/Off Switch: The hot water heating mode is controlled by a switch on the back of the unit, next to the cooling mode switch.

Hot Thermostat: regulated by a pre-set, non-adjustable sensor on the tank.

Hot Button (incorporates safety lock): Press once to unlock. Press again to dispense hot water. (Note: Machine will revert to locked after 5 seconds if dispense is not activated.)

Hot LED: Indicates hot application is switched on.

Components

Major Components & Water Connection

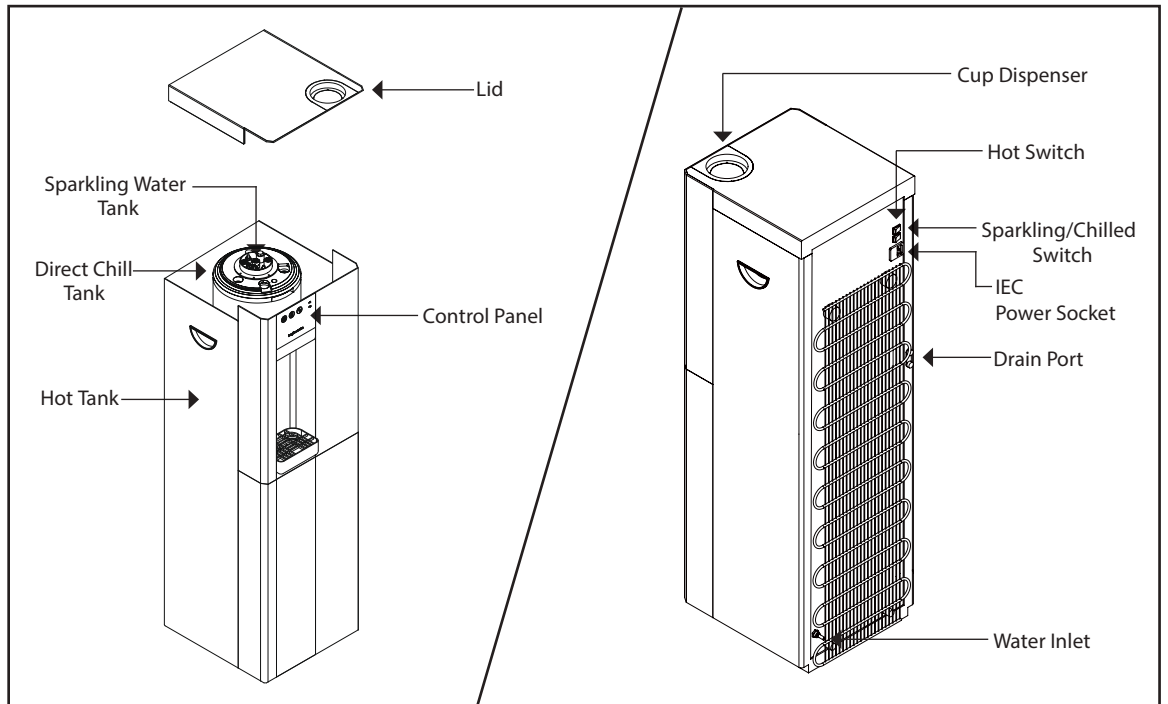

Operation

Water Connection & Operation

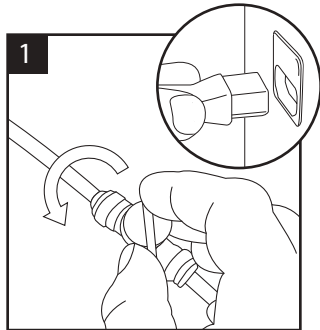

1
Connect and turn on the water supply. Then connect the power supply.

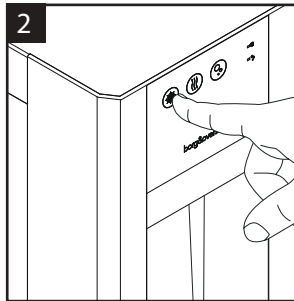

2
Press and hold the cold water button until water comes out.

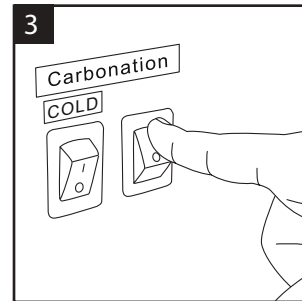

3
On sparkling models turn on the carbonation switch on the back of the unit.

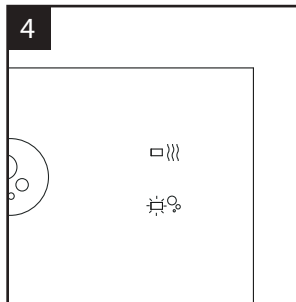

4
The relevant indicator lights will be lit.

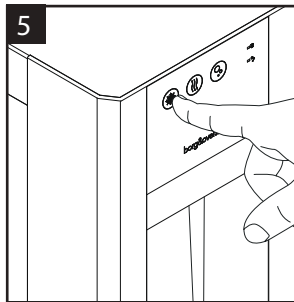

5
All hot & sparkling tanks must be purged of air by holding the corresponding button. Do not switch the hot system on until tank has been purged.

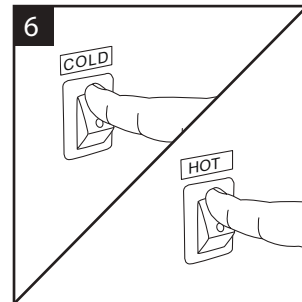

6
To avoid damage do not turn on the cold or hot power switches until waterflows out of the machine. (If applicable)

Water Connection & Operation (Continued)

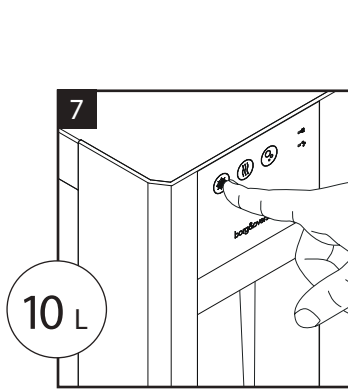

Flush through 10 litres of water before use.

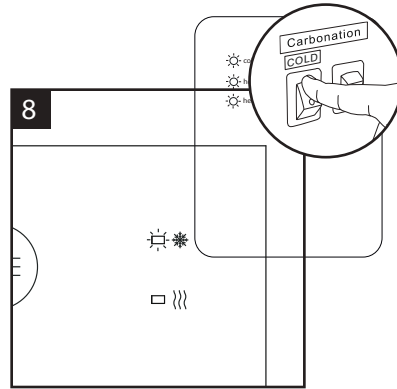

When the cold water switch is turned on, the cold water and indicator will be lit.

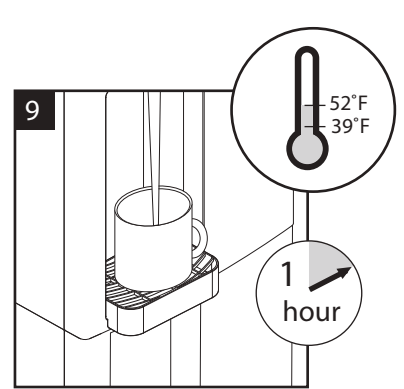

The temperature of cold water can be set from 39°F to 52°F. Allow up to 1 hour for the water to reach its minimum temperature.

CO2 Bottle Installation (Sparkling Versions Only)

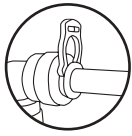

IMPORTANT! ALWAYS ENSURE SECURITY CLIPS ARE USED ON ALL WATER AND CO2 CONNECTIONS.

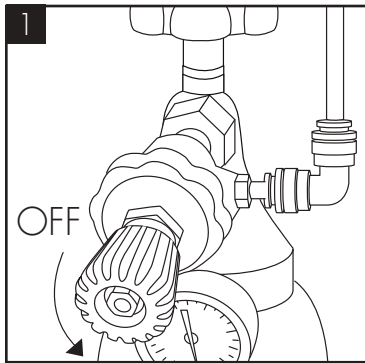

1 Attach the regulator to the disposable CO2 bottle, ensuring the regulator is closed.

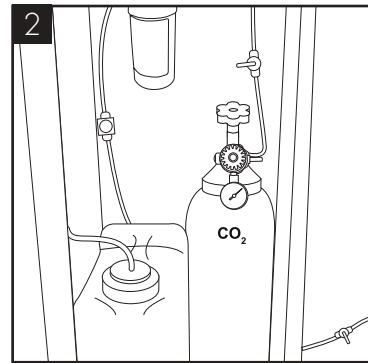

2 Connect the assembled CO2 bottle and regulator to the machine using 1/4 inch pipe.

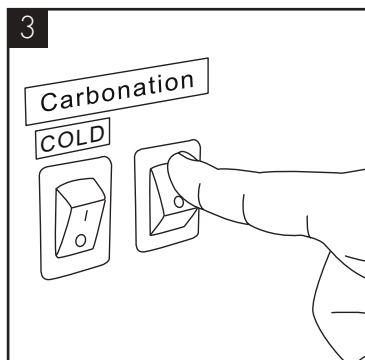

3 After completing the water installation, turn on the sparkling power switch and the pump will run. Do not open the regulator valve until the carbonated switch has been turned on.

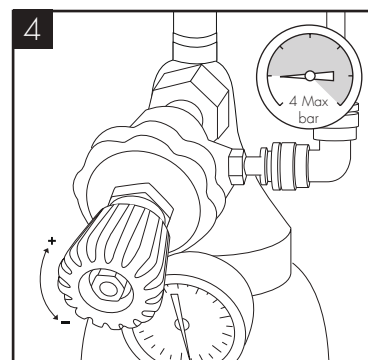

4 We recommend between 3.5 - 4 bar. Do not exceed 4 bar pressure.

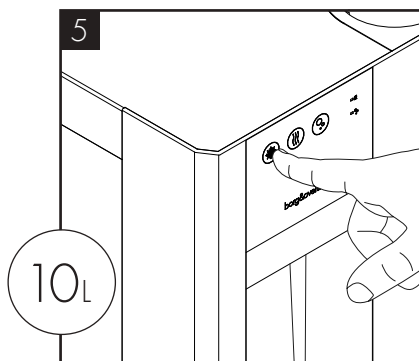

5 Flush through approximately 10 litres of sparkling water. Check and adjust the CO2 pressure accordingly.

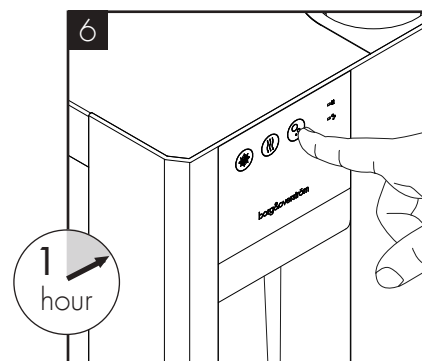

6 Following installation, it will be necessary to leave the machine for up to 1 hour for the initial chilling cycle to occur.

Functions & Controls

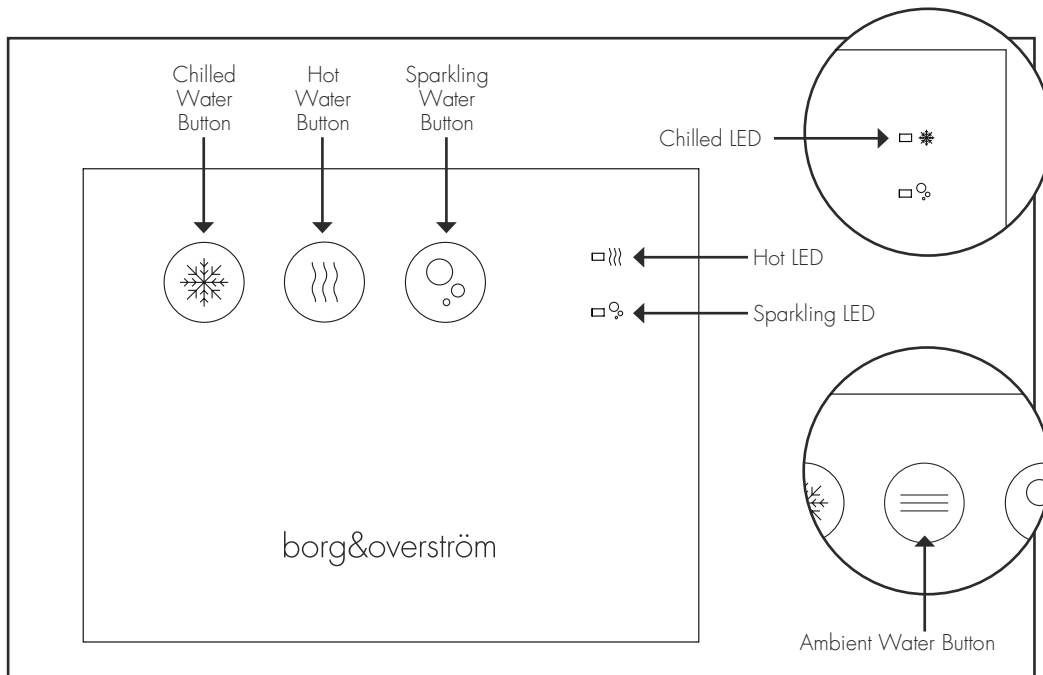

General Safety

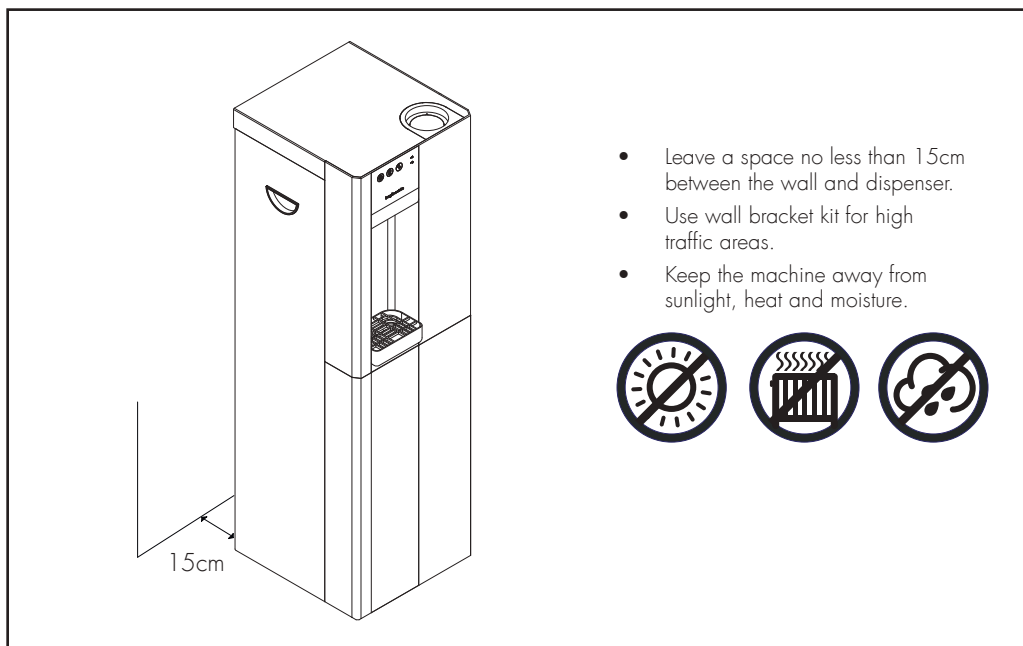

Maintenance

NOTE: All maintenance operations must be carried out with the dispenser switched off.

Isolation & Removal

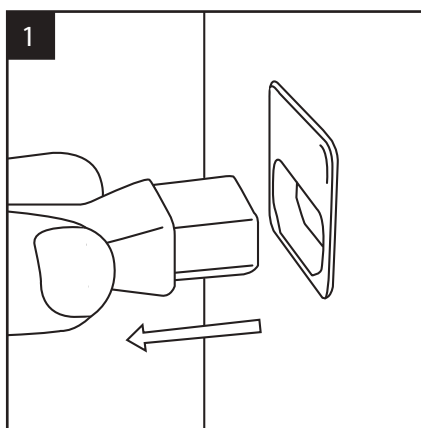

Please make sure the machine is completely disconnected from electricity before carrying out any maintenance work.

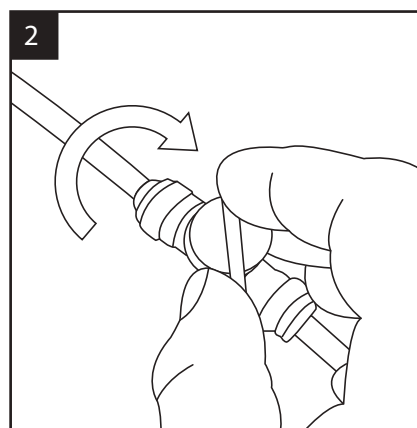

Turn off the water supply.

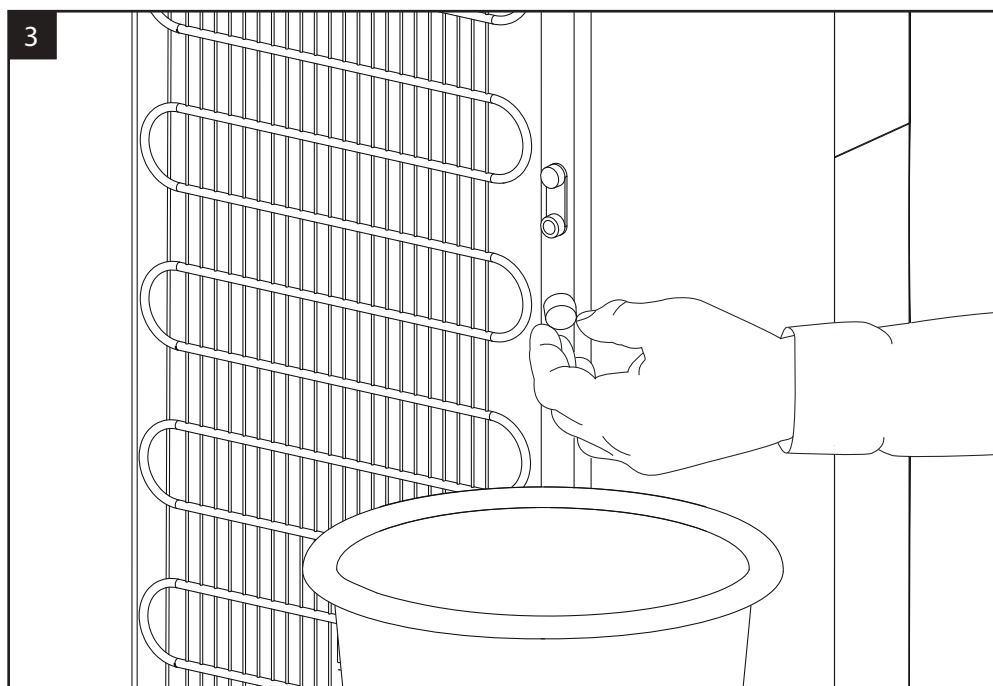

To drain cold and ambient units, simply push each dispense button until no water dispense. For cold and hot dispensers push the dispense until no water dispenses and then remove both drain port caps to empty the water tanks.



Caution: hot water may spill from the hot tank during this operation.

Sanitisation Guide

NOTE: Before beginning the sanitation process please ensure that water is turned off at the mains and refer to the sanitisation liquid MSDS documentation for further information. Use bioguard hand gel and ensure gloves are worn.

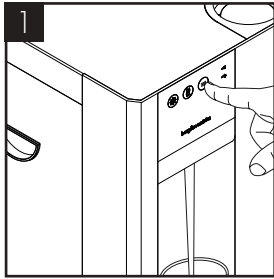

Briefly press chilled/ambient dispense buttons to release internal water pressure from the machine.

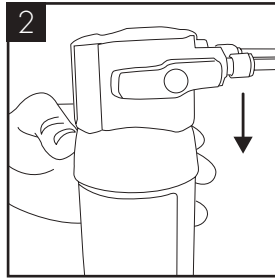

Remove the existing cartridge.

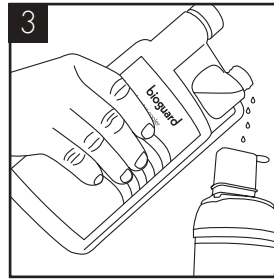

Add 25 ml of Bioguard Internal Sanitisation fluid to a clean and empty service filter cartridge.

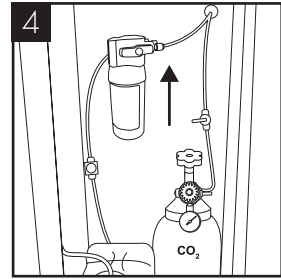

Connect the service cartridge to machine.

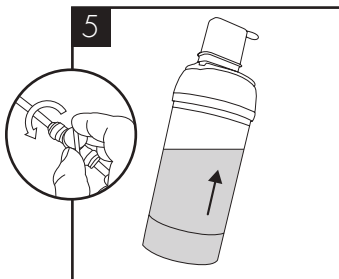

Turn on incoming water, allow service cartridge/doser to fill.

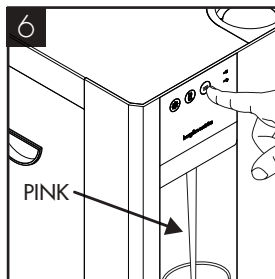

Dispense water using the cold button until the water appears pink. Repeat with sparkling button if present. Briefly press the ambient button too.

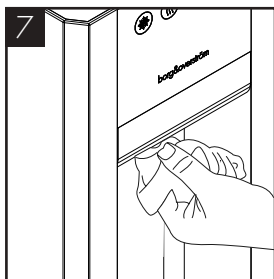

Leave the solution inside machine for sanitisation (minimum 5 minutes) while thoroughly cleaning the machine externally, pay particular attention to the dispense faucet and buttons.

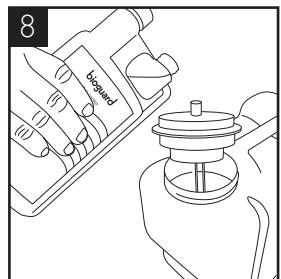

If a Waste Overflow System is fitted, empty this and flush through with a small amount of sanitisation fluid if needed. Remember to include the drip tray and connecting pipe work.

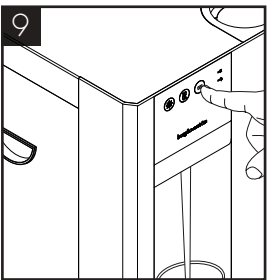

When the external cleaning (after a minimum of 5 minutes) is completed, flush the machine using the chilled button with clean water until the dispense water runs clear. Repeat briefly with the ambient button.

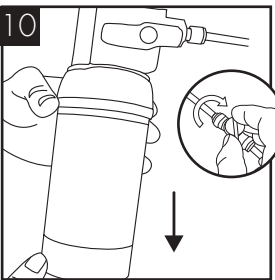

Turn off water and remove the service filter. Retain service filter for reuse.

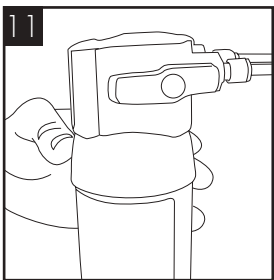

Fit new filter. Turn on incoming water supply.

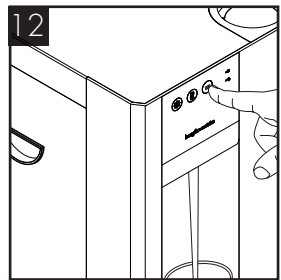

Pre-flush the new filter to waste using the ambient button until the water appears clear and is free of air. Flush through a small amount of water to check all functions.



Please note that this sanitisation fluid contains an active caustic/alkaline agent. Always use responsibly and with care remembering that due to its alkaline nature unnecessary concentrated/prolonged contact with any materials, including metals, can cause damage. Always rinse all contact surfaces after use with clean water.



Avoid skin contact and wear protective gloves when handling sanitisation fluids



In the event of any skin contact, flush immediately with clean, cold water

Leak Detection (power cut off) - All Variants Enhanced Leak Detection (Flood prevention) Available as Optional Extra.

NOTE: If this machine is equipped with a leak detection device. When leaking is detected the dispense operation will be cut off automatically.

To reset:

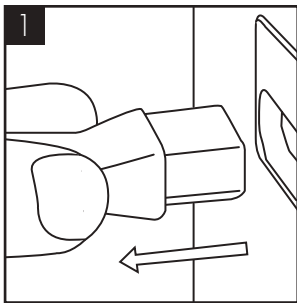

Unplug the machine.

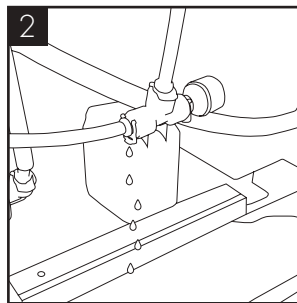

Locate the source of leakage and rectify.

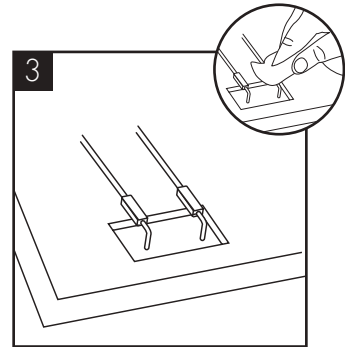

Locate the detection probe which can be found in the bottom rear middle section. Dry the probes and internal area with a dry cloth.

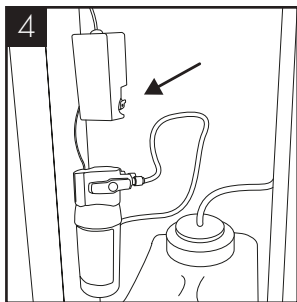

If enhanced Leak Detector is fitted as optional extra: locate the Leak Detector valve.

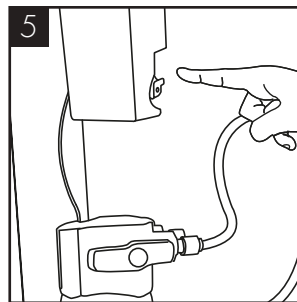

Reset the red lever (push it in).

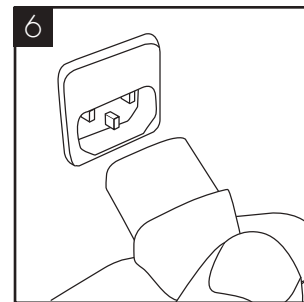

Reconnect the power to machine and test operation.

If leak detector is fitted as optional extra, reset the red lever (push it in)

Emptying the carbonation tank for transportation

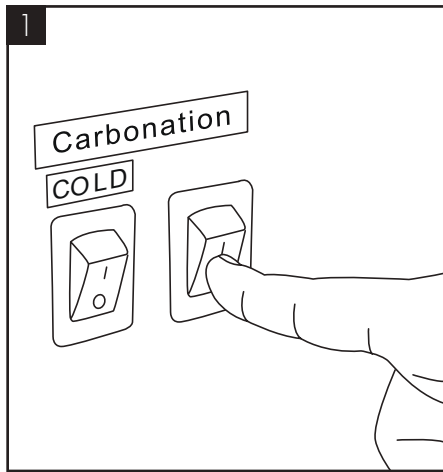

Switch off the Carbonation System switch on the back of the unit.

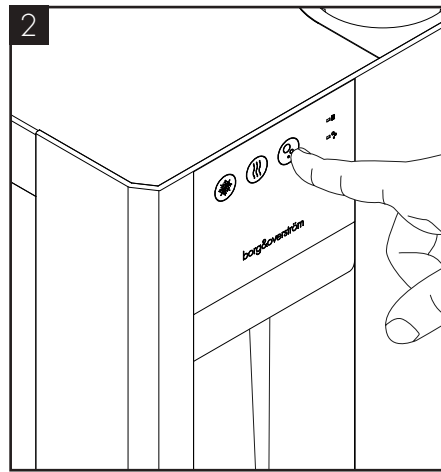

Press and hold the Sparkling water dispense button until all water is expelled.

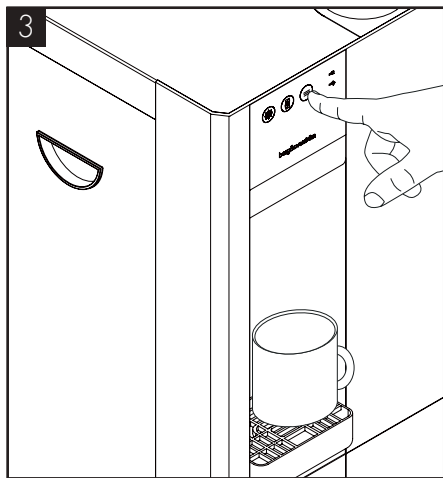

The tank is empty of sparkling water when only CO₂ is being released.

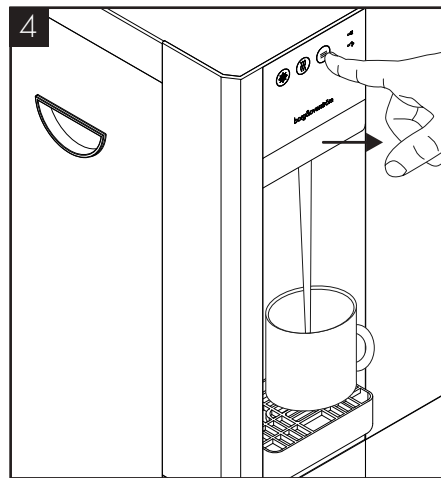

Ensure to release the Sparkling water button and take care to avoid releasing excess amounts of CO₂ gas.

Advanced Troubleshooting

Fault Diagnosis: No Water Dispenses

Problem/Report	Possible Cause	Suggested Action
From Ambient Dispense	Water Supply turned off	Check all that taps/valves/ filters on the incoming supply are fitted and are turned on.
	"Waterblock" tripped off (and tank empty).	Reset "Waterblock" (and check for any leaks).
	"Leak detector" (if fitted) tripped off (and tank empty).	Disconnect the power and water supply, reset the machine (check for leaks).
	Solenoid not working	Dismantle and check the solenoid, completely replacing the solenoid as necessary.
	No Electricity/Power Supply.	Check power cord is connected and live. Check machine is switched on.
	Blocked tank outlets/pipes.	Check and unblock or replace as needed.
	Control PCB not working	Check/replace Control PCB
From Cold Dispense	Firstly all as for Ambient Dispense.	Carry out checks and actions as for ambient dispense.
	Chiller tank frozen – Thermostat set too low.	Thaw out the machine and increase cold water temperature.
	Chiller tank Frozen - Thermostat not working.	Thaw out the machine and check thermostat. Replace Cold Water thermostat as needed.
	Chiller tank frozen.	Circulation Pump not working / Thaw out the machine and check circulation pump. Replace Circulation pump as needed.

Problem/Report	Possible Cause	Suggested Action
From Hot Dispense	Firstly all as for Ambient Dispense.	Carry out checks and actions as for ambient dispense.
	Airlock in dispense pipe work.	Unblock/replace hot water pipe and hot vent pipe.
	Tank filled with limescale.	Replace tank.
From Sparkling Valve	Firstly as for ambient and cold valve.	Carry out the checks and actions as for cold and ambient.
	Low or no CO2.	Check and replace cylinder as necessary.
	Pump not operating.	Check carbonator level control system.
		Check probes connected/Leads attached. Check power supply to pump.
	Carbonator Tank over pressurised with CO2.	<ol style="list-style-type: none"> 1. Switch the Sparkling System off. 2. Shut off CO2 supply. 3. Press the Sparkling Water button to release CO2 from carbonator. 4. Switch the Sparkling system on. 5. Check pump operation is running normally. 6. Wait for the pump to stop running. 7. Re-open CO2 supply.
	Pump Feed Solenoid Valve.	Check function/condition and repair/replace accordingly.
Carbonation System switched off.	Switch on (Switch on back of the machine).	

Fault Diagnosis: Water Dispenses but not Correct Temperature

Problem/Report	Possible Cause	Suggested Action
Ambient Water too Warm	Low usage and/or heat from compressor influencing stored water.	Check tank insulation and/or advise customer.
	High usage and/or water supply pipe in warm ducting.	Advise customer.
Cold Water not Cold	Cooling switched off.	Check switch positions as necessary.
	Compressor runs and switching off (cool/warm to touch) - Thermostat set too high.	Decrease cold thermostat set point.
	Thermostat not working.	Check/replace thermostat.
	Compressor runs but not switching off (hot to touch).	Please contact technical support.
	Refrigeration problem.	Please contact technical support.
	Compressor not running at all - No electricity power supply.	Check the Power cord is connected and live, and the machine is switched on.
	Compressor only hums slightly/briefly.	Check and replace relays.
	Relays loose.	Check and refit relays.
	Compressor not working.	Please contact technical support.
	Fan not working	Check and replace, as required.
Hot Water not Hot	Hot water mode switched off.	Switch on hot water mode (status LED should show).
	Heating operation tripped off.	Reset overheat button on hot tank.
	Break in supply wiring to control circuit.	Locate break and repair.
	Hot water demand too high.	Advise user/s.
	Heating element not working.	Check and replace Hot tank as required.
	Hot tank heavily scaled (signs of scale in top of tank, loud boiling noises etc).	Carry out thorough descale or replace hot tank.
	Break in supply wiring to main element.	Locate break and repair.

Fault Diagnosis: Water Leaks

Problem/Report	Possible Cause	Suggested Action
Water lying on top edge of lower door panel and/or bottom of Cabinet.	Overflowing Drip Tray waste container.	Empty Waste Container and check drainpipe is not blocked.
Water lying in bottom of machine.	Level Sensors not working.	Check operation/repair/replace as required.
	Leak in supply inlet pipe work and/or filter.	Locate and repair accordingly.
	Leak from machine water pipe work fittings.	Locate and repair accordingly. Check pressure and fit pressure reducing valve if needed.

Fault Diagnosis: Miscellaneous

Problem/Report	Possible Cause	Suggested Action
Repeating beeping noise	Level Sensor fitted and tank full.	Empty Level Sensor tank.
No LED Control Lights	No electricity to Machine.	Check power supply and reconnect as necessary (Also check out other symptoms as described separately).
	Check Fuse in IEC Socket.	Replace if necessary.
	Control PCB not working (Machine working normally otherwise).	Check/replace PCB.
Machine Shakes on Start-up	Compressor Starting.	No action needed. This is quite normal.
	Level Surface.	
	Uneven Surface.	Level up machine using adjustable feet.
	Missing Fixings.	Replace missing fixings.
Tripping out Electricity Supply	Machine in high humidity environment.	Discuss possible repositioning with customer.
	Electrical circuitry faults.	Test, identify and address accordingly. See Electrical Diagrams.
		Please contact technical support

Fault Diagnosis: Miscellaneous

Problem/Report	Possible Cause	Suggested Action
Slow but Continuous Water Dispense from Ambient or Cold Tap	Low incoming water pressure	Consider replumbing to alternative supply if possible
		Fit Booster pump set.
Intermittent Water Dispense from Ambient or Cold Water Valve	Trapped air in pipework (especially where water pressure is low after filter change).	Hold button on to purge air out (This could take several minutes where pressure is low).
		Pre-flush filters
	Button not being pressed enough	Press button firmly. Could be caused by surrounding cold environment making the button stiffer.
	Faulty PCB	Replace PCB
Intermittent Water Dispense from Ambient or Cold Water Valve and hammering noise.	Fluctuating mains water pressure situation.	Please contact technical support.
Continuous Water Dispense from Ambient/Cold or Hot water valve.	Button jammed on/faulty.	Replace PCB or/button panel as needed.
	Debris blocking hole in diaphragm window.	Dismantle valve and clean out.

Exploded Diagrams

Chilled & Ambient

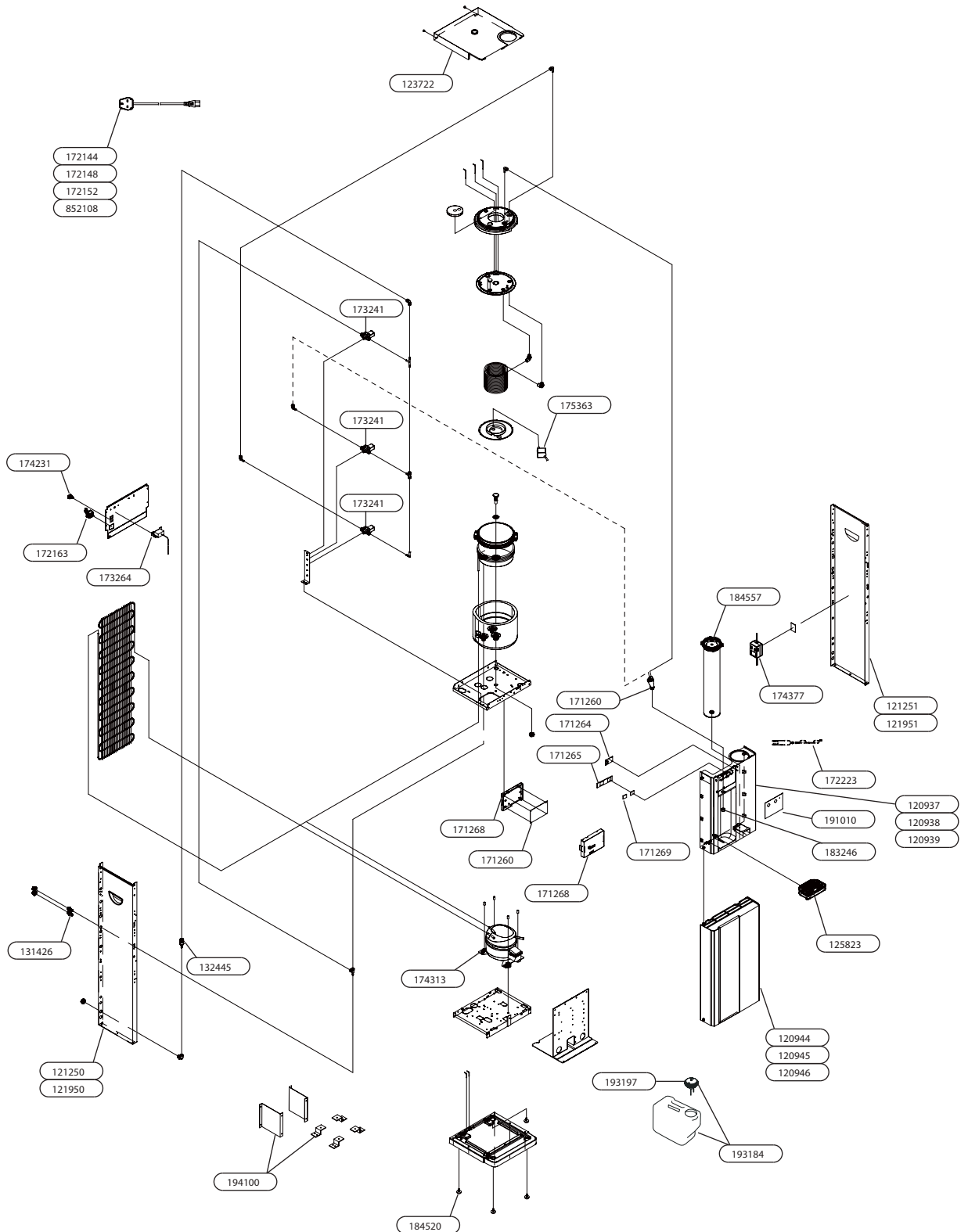

Chilled, Ambient & Hot

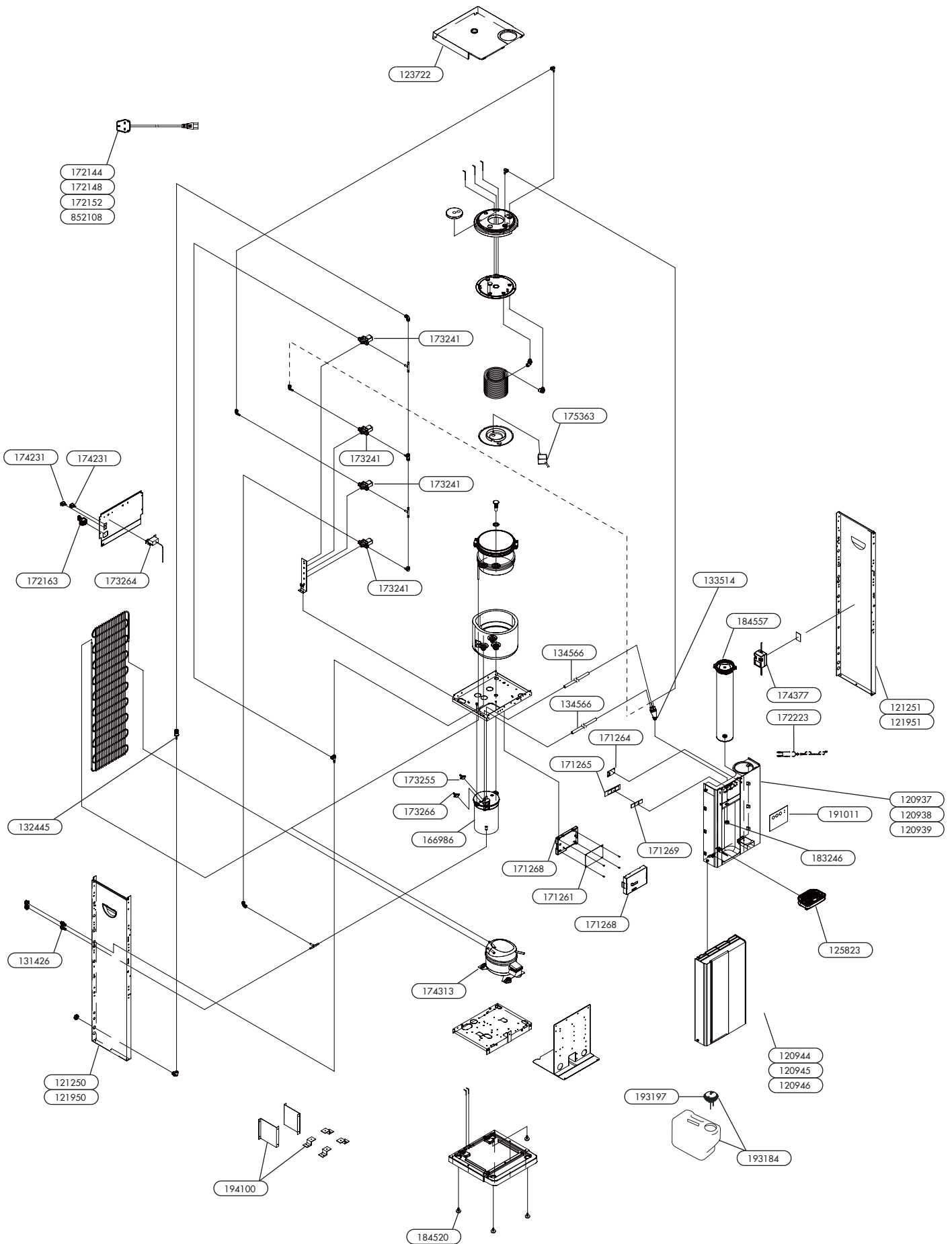

Chilled, Hot & Sparkling

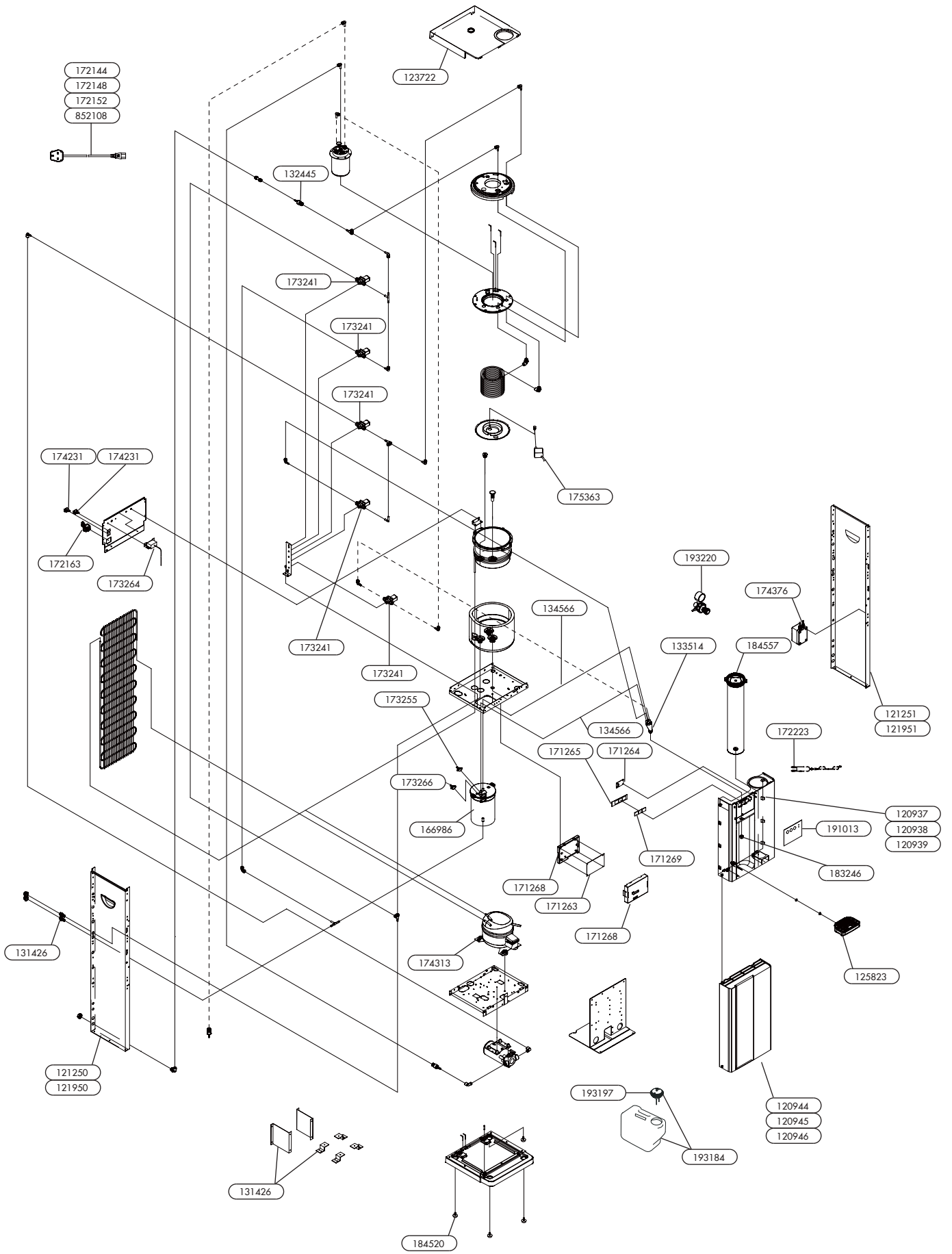

Parts List













Borg & Overstrom Part No	Description	Recommended Engineers Spares
120937	B3.2 Front Panel - Silver	
120938	B3.2 Front Panel - White	
120939	B3.2 Front Panel - Black	
120944	B3.2 Door Panel Assembly - Silver	
120945	B3.2 Door Panel Assembly - White	
120946	B3.2 Door Panel Assembly - Black	
121250	B3 Countertop Left Side Panel inc handle	
121251	B3 Countertop Right Side Panel inc handle	
121950	B3 Floorstanding Left Side Panel inc handle	
121951	B3 Floorstanding Right Side Panel inc handle	
123722	Top Cover Panel	
125823	B2.2/B3.2 Drip Tray Set - Black	
131426	2-Port Drainage Outlet	
132445	Single Check Valve	*
133514	Faucet 4 outlets	*
166986	Hot Tank	*
171260	B3.2/B4.2 Chilled & Ambient Main PCB	*
171261	B3.2/B4.2 Chilled, Ambient & Hot Main PCB	*
171262	B3.2/B4.2 Chilled, Ambient & Sparkling Main PCB	*
171263	B3.2/B4.2 Chilled, Hot & Sparkling Main PCB	*
171264	B3.2/B4.2 LED Display PCB	*
171265	Touch Panel PCB Board	*
171268	B3.2/B4.2 Main PCB Case Assembly	
171269	B3.2/B4.2 Touch Icon Illumination Diffuser	*
172144	Power Cord Set - Danish	
172148	Power Cord Set - Schuko/EURO	
172152	Power Cord Set - UK	
172163	IEC Fused Socket	
172223	B3.2/B4.2 LED PCB Wiring Loom	*
173241	HP1/4PFx1/4PFS24 Solenoid Valve	*
173255	105° Hot Tank Over-heat cut out	*
173264	Cold Temperature Thermostat	*
173266	92° Hot Tank Thermostat Sensor	*
174231	Electric Rocker Switch	*
174313	Compressor	
174376	Carbonation Pump Transformer	*
174377	Transformer 24VDC	*
175363	Circular DC Circulation Pump	*
183246	Chrome B3.2/B4.2 Faucet Shroud	*
184520	B3.2 Floorstanding Replacement Foot Set	
184557	Cup Dispenser	
191010	B3.2 Chilled & Ambient Touch Control Panel	*
191011	B3.2 Chilled, Ambient & Hot Touch Control Panel	*
191012	B3.2 Chilled, Ambient & Sparkling Touch Control Panel	*
191013	B3.2 Chilled, Hot & Sparkling Touch Control Panel	*
193184	B2/B3 Level Sensor Kit (inc Waste Container)	







Parts List

Borg & Overstrom Part No	Description	Recommended Engineers Spares
193197	Waste Alarm Module (inc Batteries)	
193220	CO2 Regulator with gauge c/w elbow	*
194100	Wall and Floor Bracket Kit	
852108	Power Cord Set - Swiss	

Technical Information

Chilled & Ambient Electrical Circuit Diagram

KEY	
	CONDENSER FAN
	TEMPERATURE PROBE
	FAN
	COMPRESSOR
	TRANSFORMER
	SWITCH
	SOLENOID
	FUSE
	PUMP
	BRIDGE DIODE
	TEMPERATURE SWITCH
	HOT WATER TANK
	LED



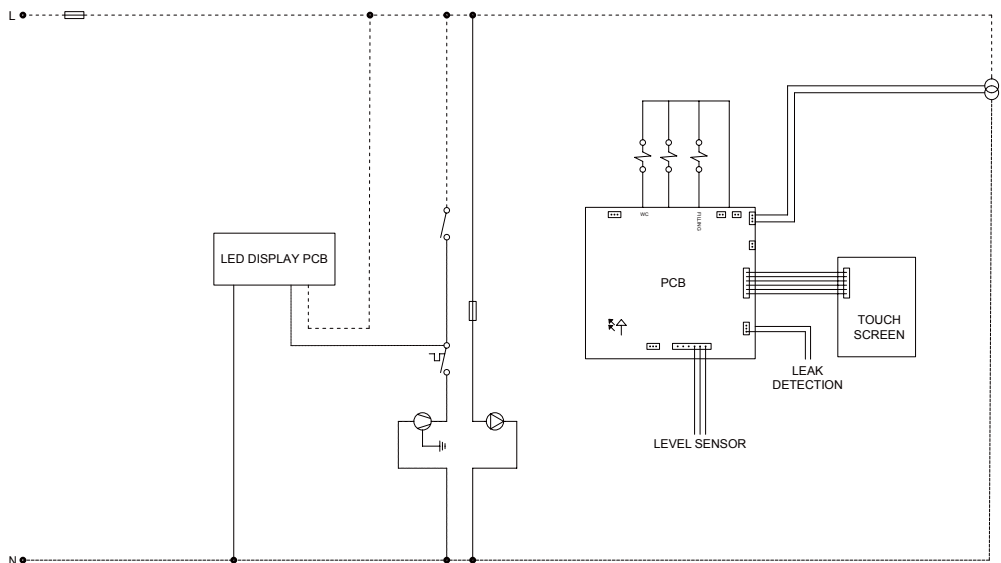



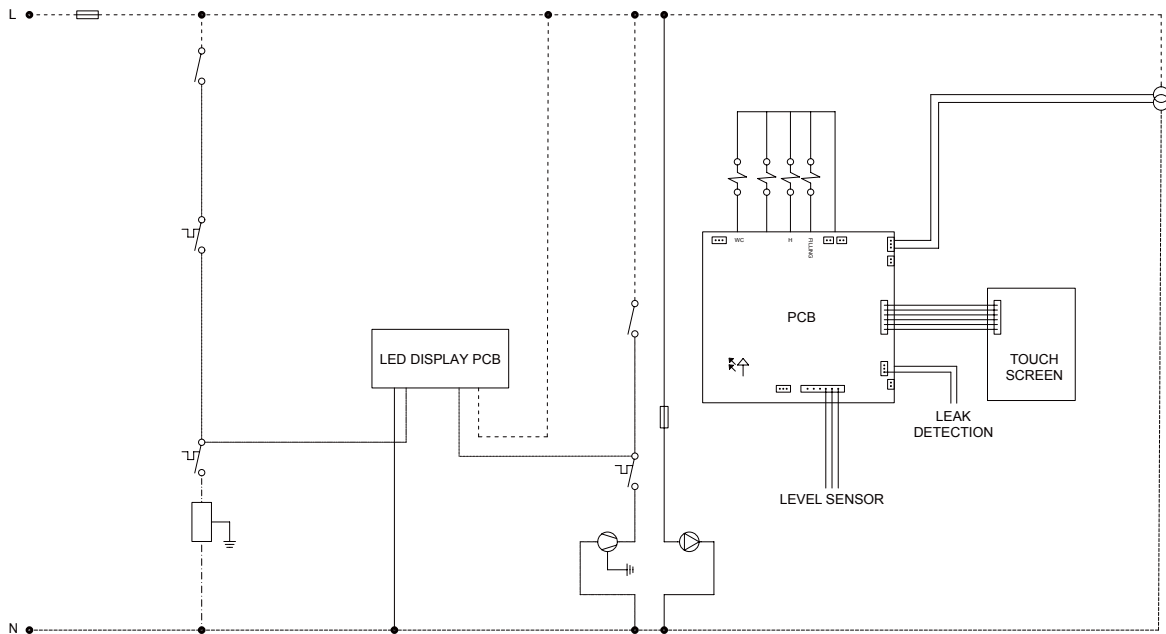
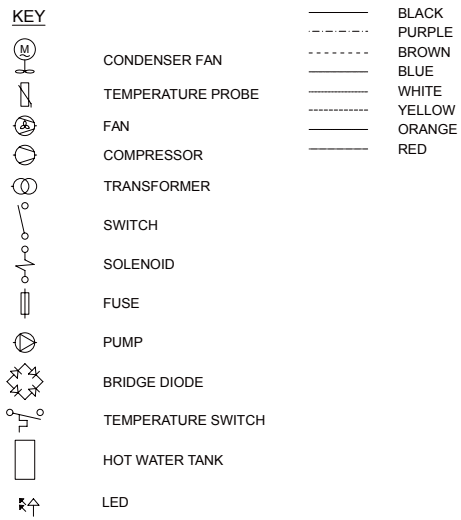







	BLACK
	PURPLE
	BROWN
	BLUE
	WHITE
	YELLOW
	ORANGE
	RED



Chilled, Ambient & Hot Electrical Circuit Diagram







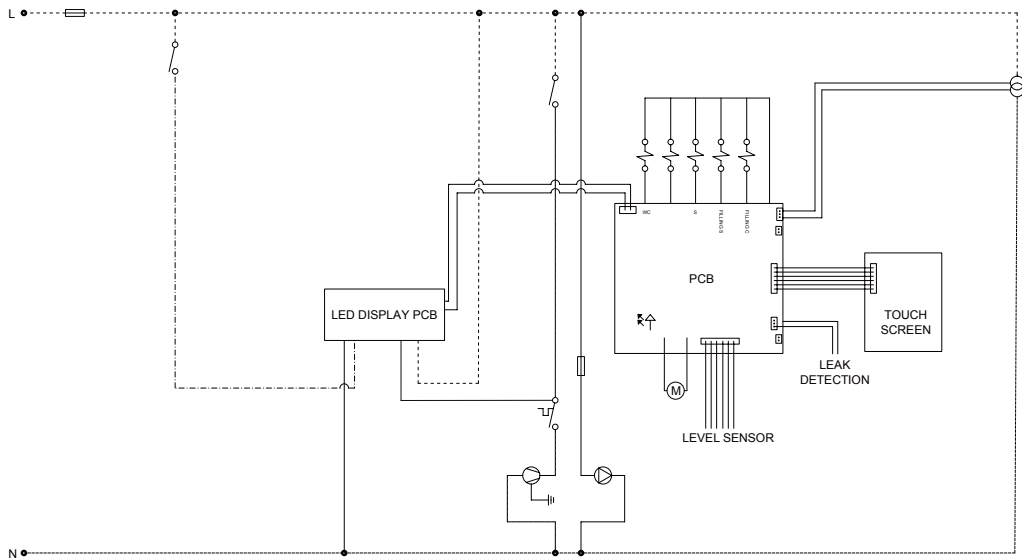

















Chilled, Ambient & Sparkling Electrical Circuit Diagram

KEY			
	CONDENSER FAN		BLACK
	TEMPERATURE PROBE		PURPLE
	FAN		BROWN
	COMPRESSOR		BLUE
	TRANSFORMER		WHITE
	SWITCH		YELLOW
	SOLENOID		ORANGE
	FUSE		RED
	PUMP		
	BRIDGE DIODE		
	TEMPERATURE SWITCH		
	HOT WATER TANK		
	LED		
	OTOR		



Chilled, Hot & Sparkling Electrical Circuit Diagram

KEY

	CONDENSER FAN		BLACK
	TEMPERATURE PROBE		PURPLE
	FAN		BROWN
	COMPRESSOR		BLUE
	TRANSFORMER		WHITE
	SWITCH		YELLOW
	SOLENOID		ORANGE
	FUSE		RED
	PUMP		
	BRIDGE DIODE		
	TEMPERATURE SWITCH		
	HOT WATER TANK		
	LED		
	OTOR		

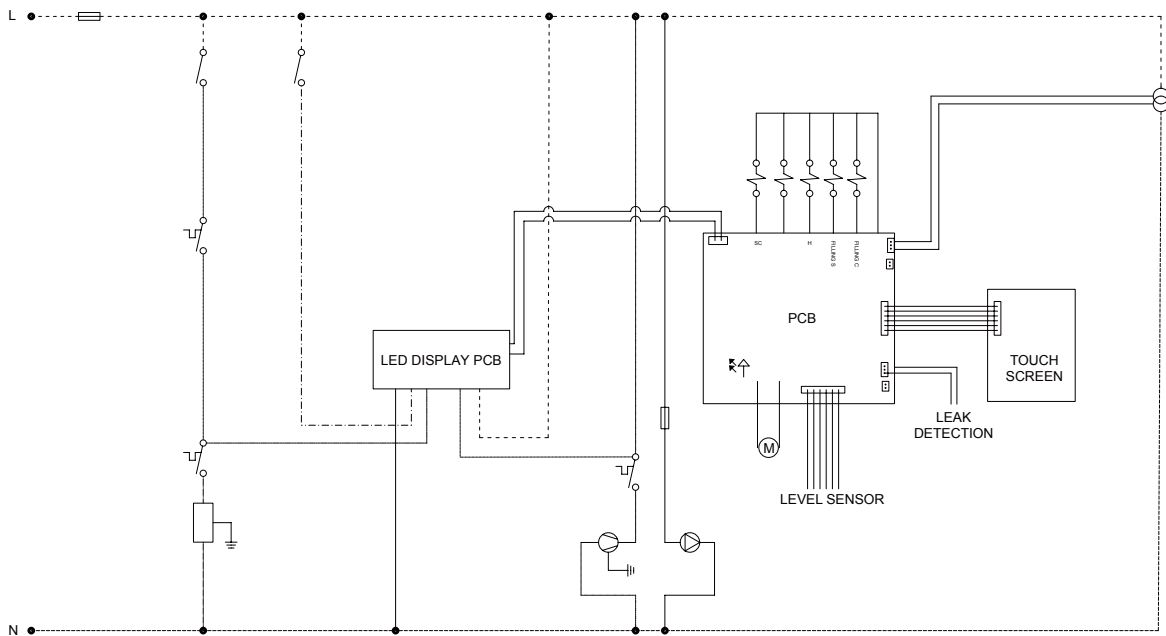

Chilled & Ambient Water Pathway

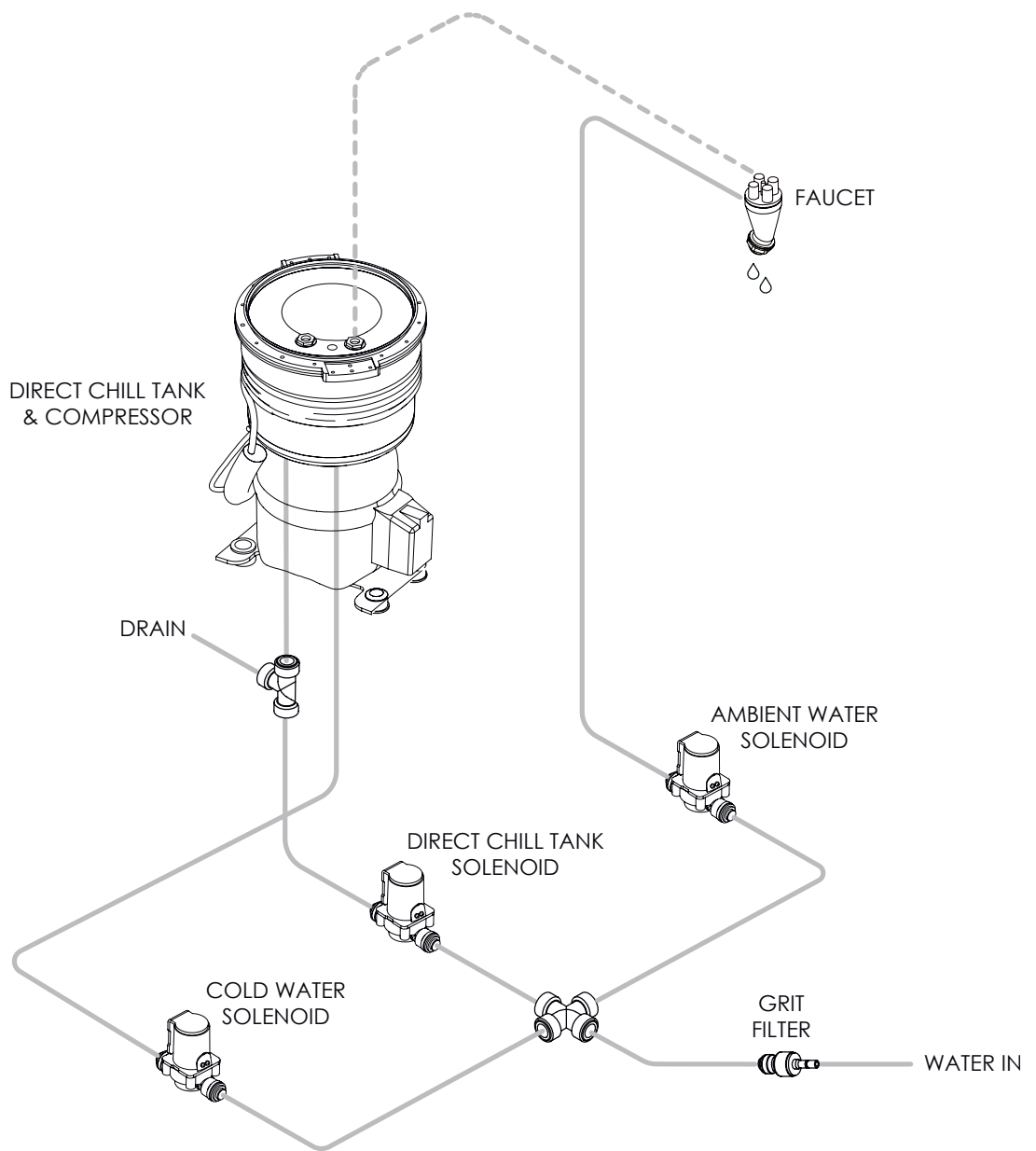

Chilled, Ambient & Hot Water Pathway

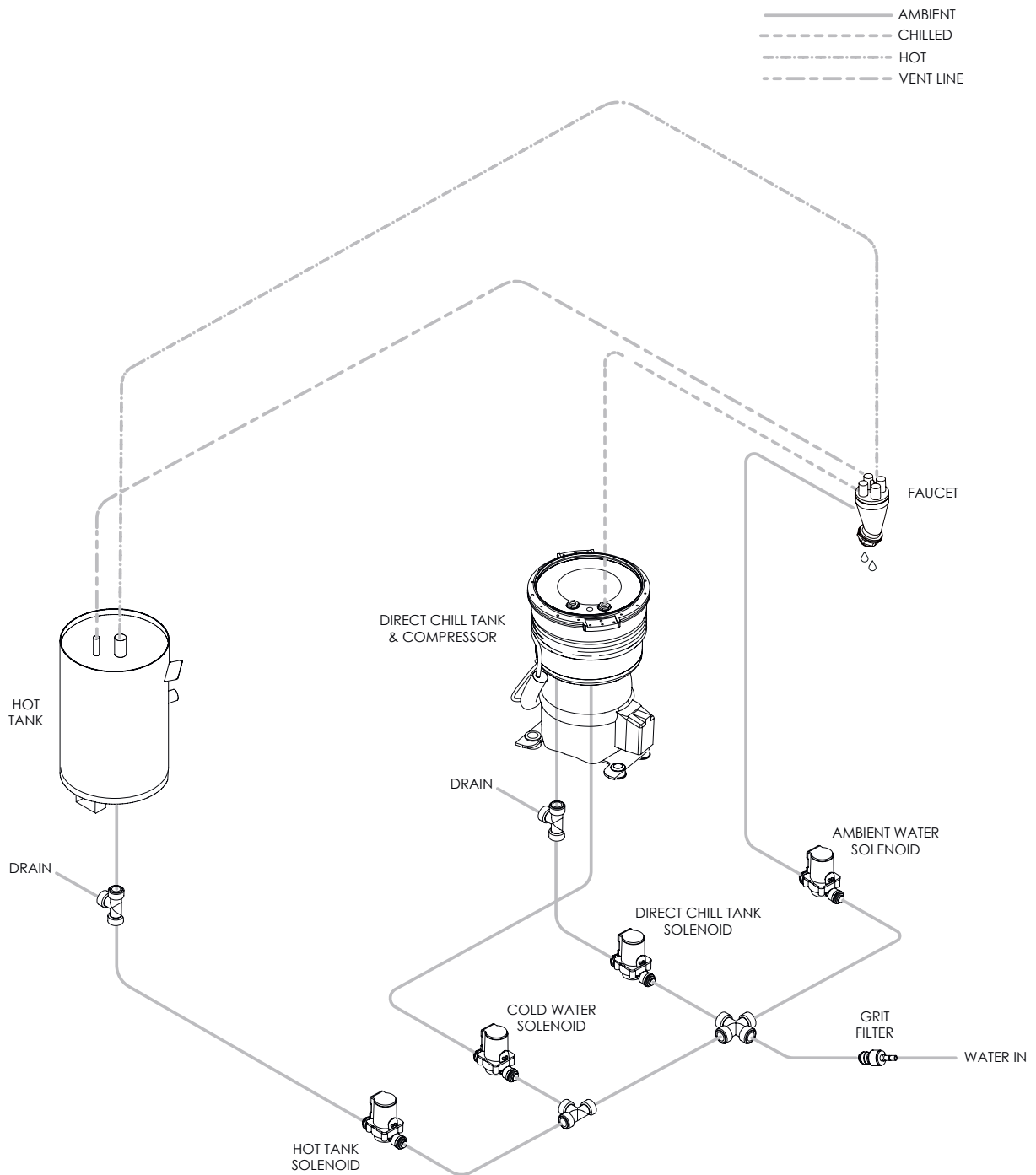

Chilled, Ambient & Sparkling Water Pathway

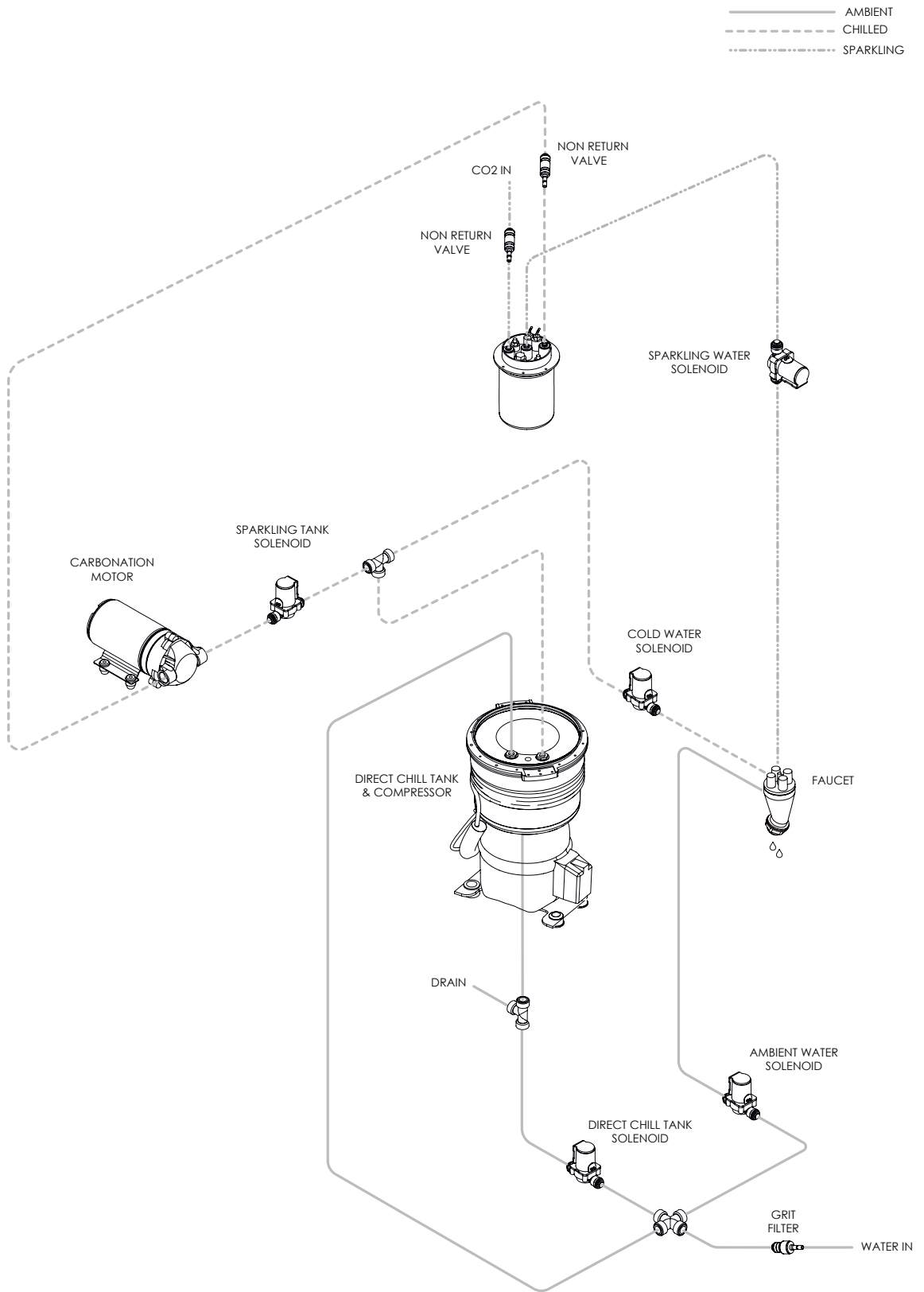

Chilled, Hot & Sparkling Water Pathway

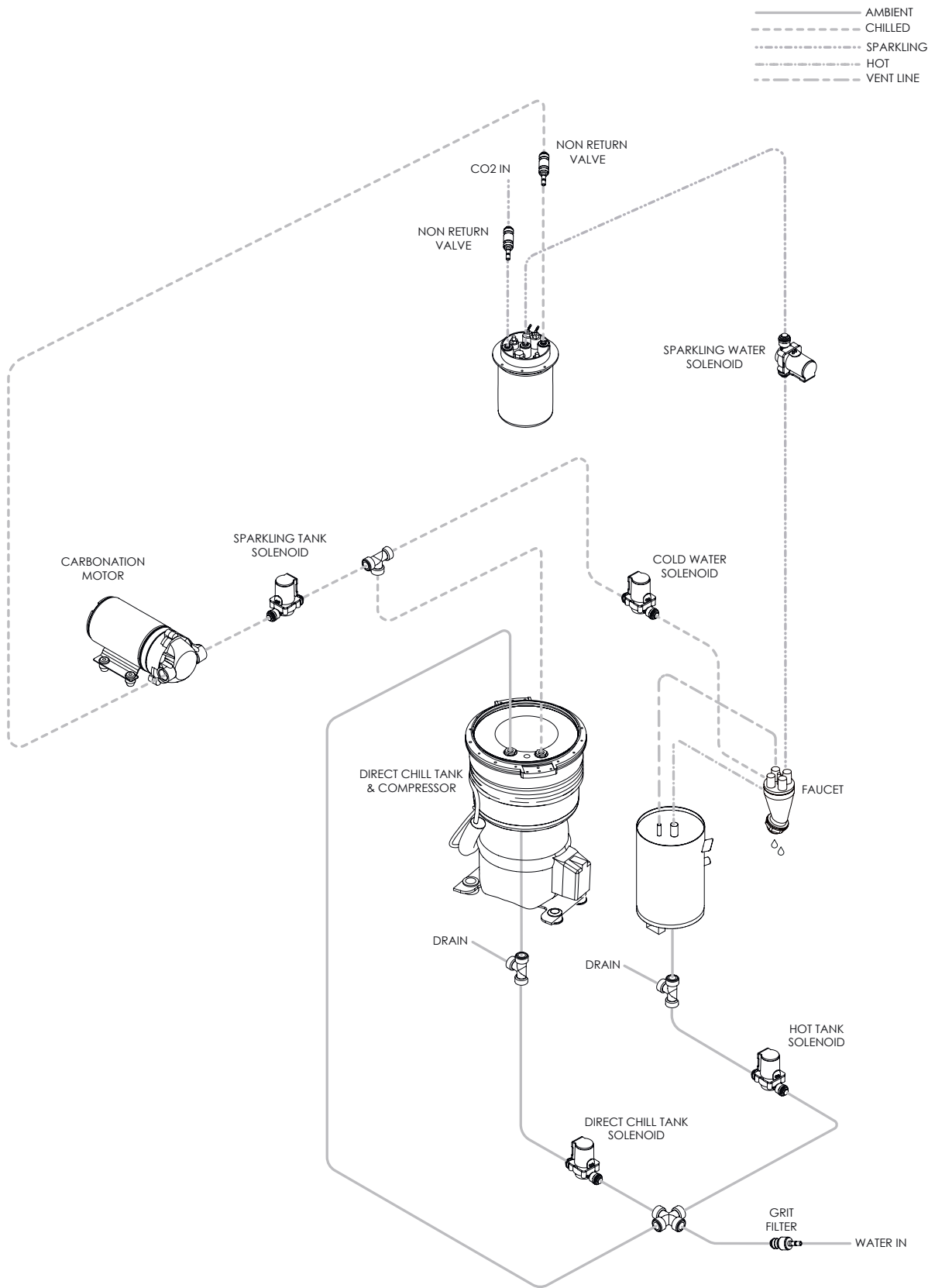



Customer services:

Email: rmiller@youraquaessentials.com

Call: 1 (615) 942-7867

Fax: 1 (615) 345-0500

Telephone
(615) 942-7867
Email
rmiller@youraquaessentials.com

Aqua Essentials
1416 Antioch Pike, Suite 103
Nashville, TN 37013

www.youraquaessentials.com

Verson : 121718 - 01