

borg & overström B4

Dispense options

Chilled & Ambient
Chilled, Ambient & Hot
Chilled, Ambient & Sparkling
Chilled, Hot & Sparkling



Chilled



Ambient



Hot



Sparkling

Contents

2	Model Overview
	2 Introduction
	3 Controls
	4 Floor standing Version
5	Installation
	5 Major Components
	5 Water and CO2 Connection
	6 Level Sensor Assembly
7	Operation
	7 Water Connection & Operation
	9 CO2 Bottle Installation
	10 Functions & Controls
	10 General Safety
11	Maintenance
	11 Isolation & Removal
	12 Sanitisation Guide
	13 Leak Detection
	14 Emptying the Carbonation Tank
15	Advanced Troubleshooting
20	Exploded Diagrams
27	Technical Information
	27 Electrical Circuit Diagrams
	31 Flow Diagrams

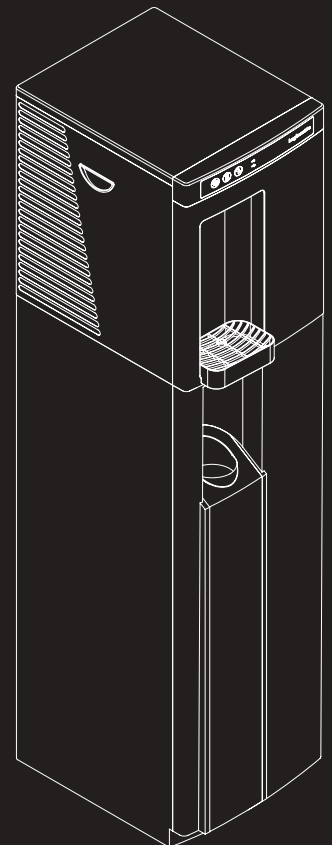



Model Overview

Introduction

A range of compact water dispensers, available in the following operational types:

- Direct Chill Chilled & Ambient (Low Pressure Tank System)
- Direct Chill Chilled, Ambient & Hot (Low Pressure Tank System)
- Direct Chill Chilled & Ambient
- Direct Chill Chilled, Ambient & Hot
- Direct Chill Chilled, Ambient & Sparkling
- Direct Chill Chilled, Hot & Sparkling

The B4 model is available as a countertop with a matching base cabinet in three colours.

All Models

All models are self-contained machines with robust steel framed cabinets and attractively injection moulded plastic front, side and top panels. An IEC Power Lead is supplied for connection to the IEC socket located at the rear of all models (An additional Schuko type is supplied for the European market).

Chilled

Water is fed into the insulated cold tank under mains pressure. We strongly recommend a Pressure Reducing Valve is fitted to all supplies to regulate the pressure to 3.5 bar/355 KPat. The cold tank is chilled via the evaporation coil of the capillary controlled refrigeration compression system. The cold temperature is thermostatically controlled via the adjustment screw on the cold thermostat. This is factory set and it is not necessary to adjust in most cases (see Controls).

Ambient

Water bypasses the cold tank for the ambient dispense.

Sparkling

Water is chilled as it passes through the Direct Chill coil. It is pumped under pressure into the carbonator which is fitted within the Direct Chill coil. The carbonator is also level controlled. The Deep Sparkle effect occurs through saturation with CO₂.

All models also incorporate a leak detection device within the unit which disables the dispense function until rectified.

Hot

Hot water is provided by a hot water tank with an integrated heater element. The water is supplied directly into the tank under the pressure as connected into the back of the unit. The water fills the tank and hot water is dispensed by displacement. The water flow is controlled by a solenoid.

Direct Chill

Borg & Overström Direct Chill utilises innovative technology to chill water instantly. We recommend this system for more demanding environments because of its optimum dispense performance and unrivalled hygienic qualities. Superior to the gravity fed Reservoir system, Direct Chill technology chills water on demand for the ultimate drinking experience.

Controls

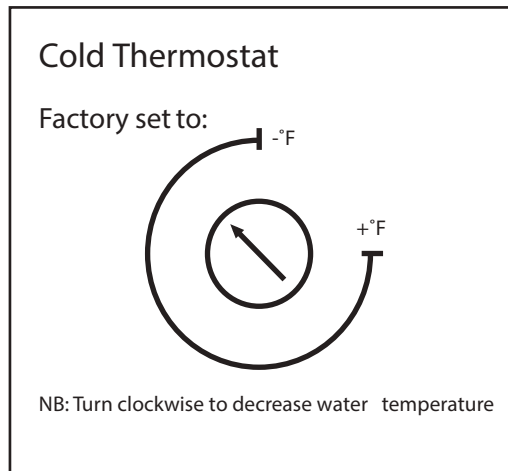

Chilled

Chilled On/Off Switch: at upper rear of machine, switches cooling operation on/off.*

Cold Thermostat: at rear of machine.

Chilled Button: Press to dispense cold water.

Chilled LED: Indicates chilling application is switched on.

10A Fuse: On rear of machine, integral with IEC socket.

*All Direct Chill variants incorporate an auto-fill system

Ambient

Ambient Button: Press to dispense ambient water.

Sparkling

Carbonation On/Off switch: Switches sparkling operation on/off.

Sparkling Button: Press to dispense sparkling water.

Sparkling LED: Indicates sparkling application is switched on.

Hot

Hot On/Off Switch: The hot water heating mode is controlled by a switch on the back of the unit, next to the cooling mode switch.

Hot Thermostat: regulated by a pre-set, non-adjustable sensor on the tank.

Hot Button (incorporates safety lock): Press once to unlock. Press again to dispense hot water. (Note: Machine will revert to locked after 5 seconds if dispense is not activated.)

Hot LED: Indicates hot application is switched on.

Floor standing Version

All models are designed to fit straight onto the top of the base cabinet to create a floorstanding model.

Ensure the feet are in the nesting positions.

The Door Panel is hinged and fastened with Magnetic Catches. The cabinet can be levelled using the adjustable feet. Service entry is at the back of the machine.

Every Base Cabinet is supplied with a Level Sensor Kit, comprising of:

- A water container.
- Sensor unit (c/w 2 no. CR3032 batteries). (Requires some assembly – see page 7.
- Drip Tray with Drainage Outlet.
- Interconnection kit between unit and cabinet – see page 24.

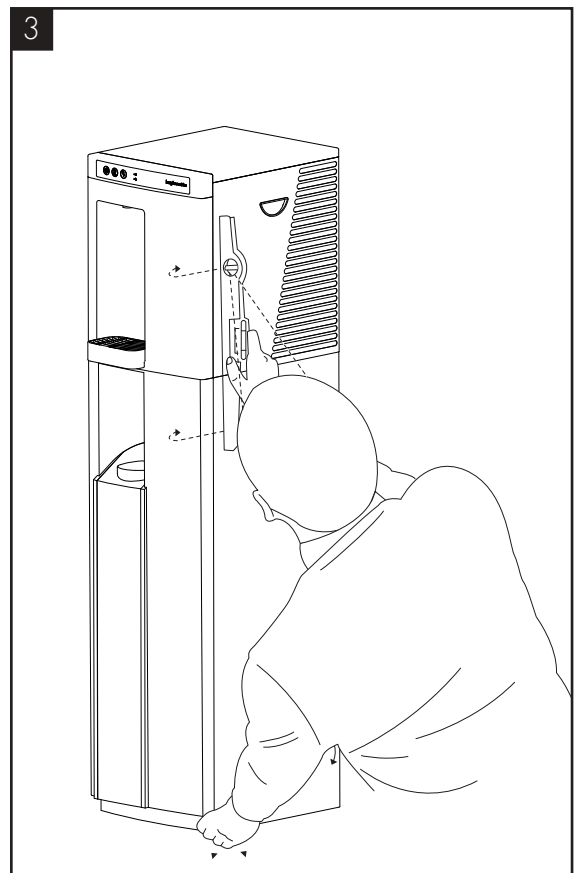
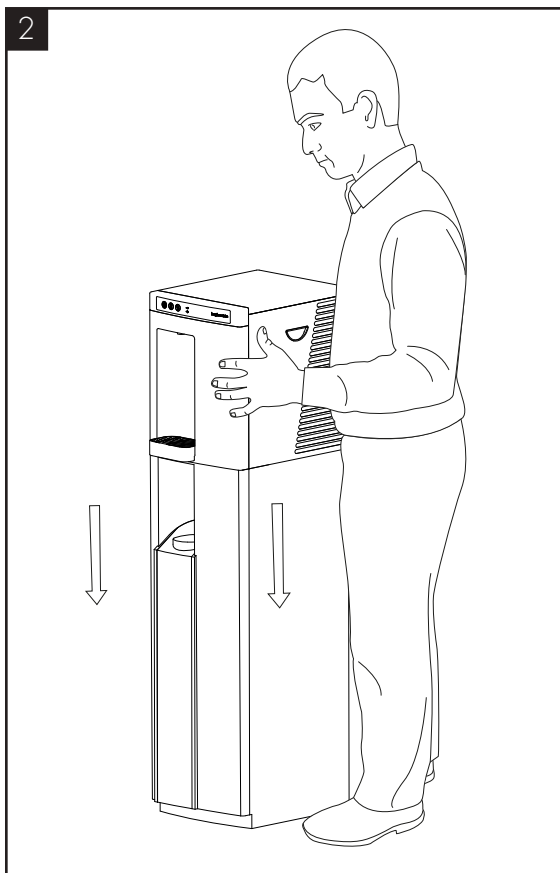
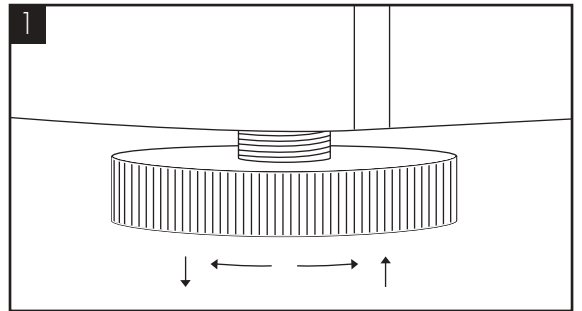

Installation

Major Components

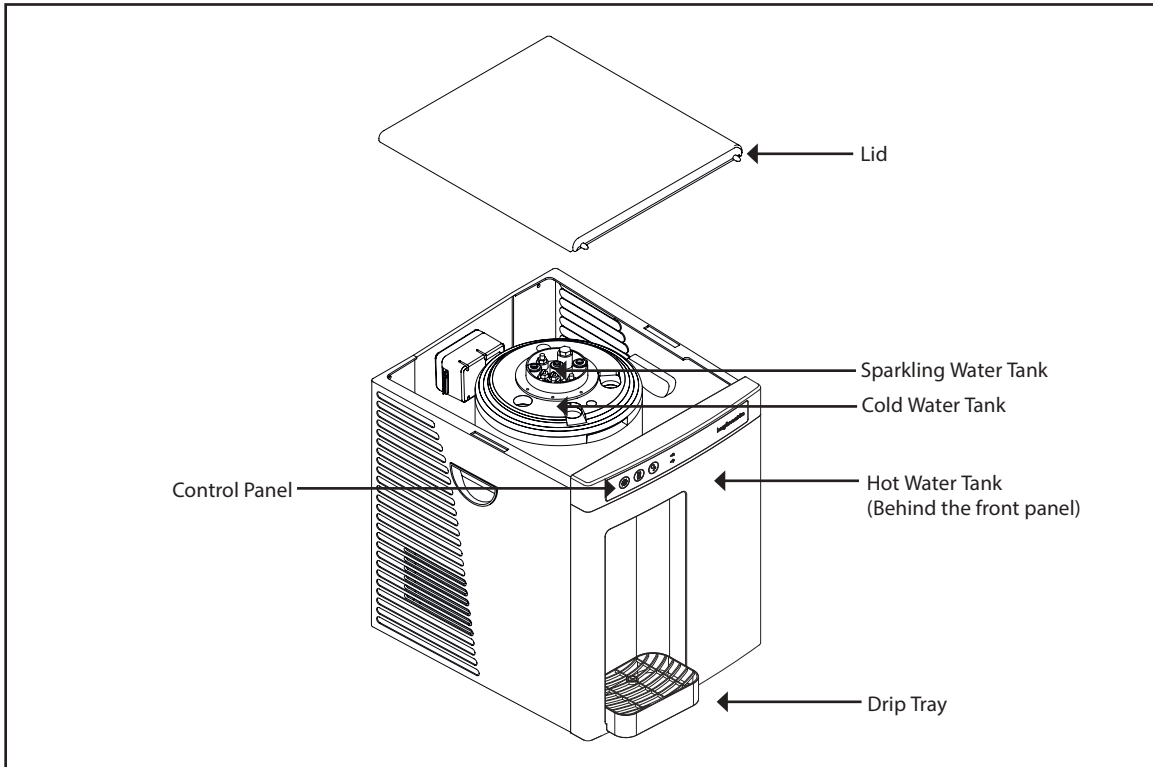

Water & CO2 Connection

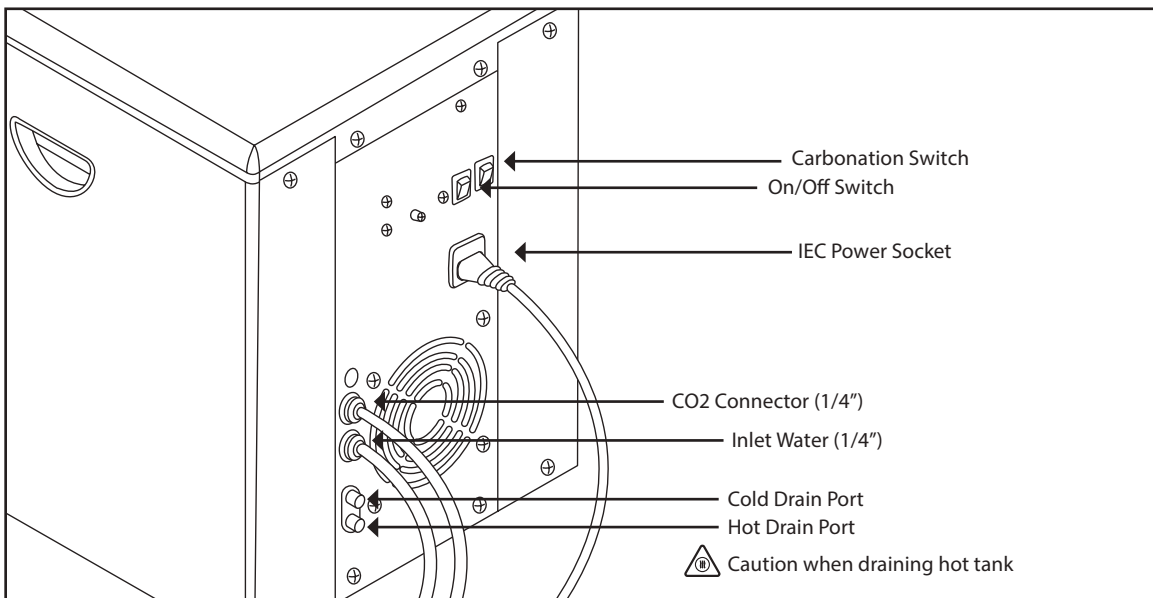

Level Sensor Assembly

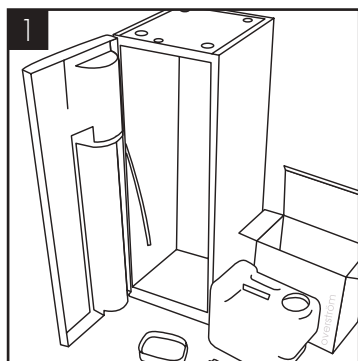

Check all parts are present.

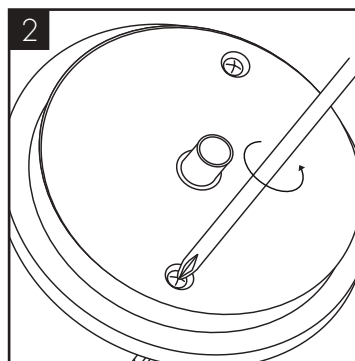

Unscrew lid.

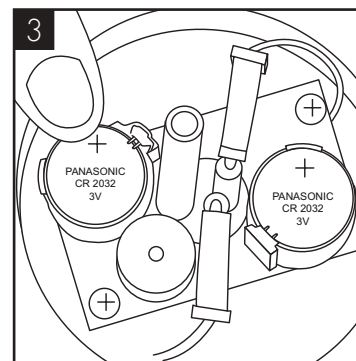

Fit both batteries and refit lid.

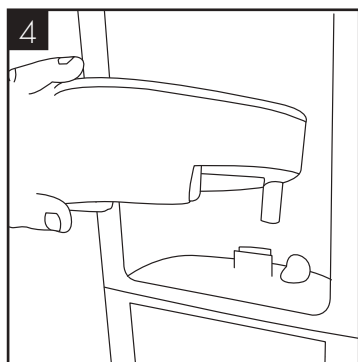

Exchange the drip tray.

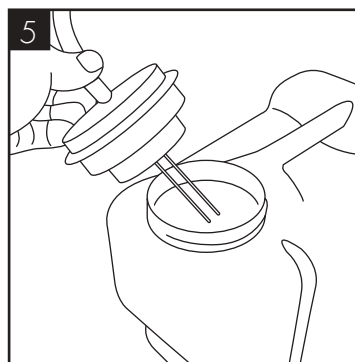

Connect the drainage tubing that is pre-fitted down the front left hand side of the cabinet.

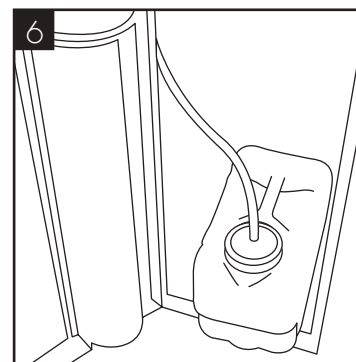

Level sensor positioned in container.

NOTE: A WARNING TONE WILL SOUND WHEN THE WATER RISES (3 BEEPS EVERY 1.5 SECONDS REPEATED). UPON EMPTYING THE CONTAINER THE WARNING TONE WILL STOP. CONTINUAL BEEP INDICATES LOW BATTERY POWER.

Operation

Water Connection & Operation

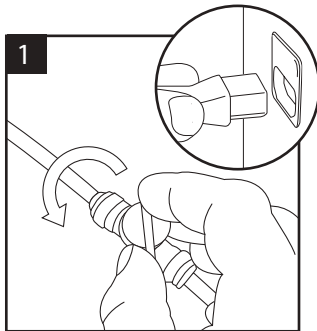

1
Connect and turn on the water supply. Then connect the power supply.

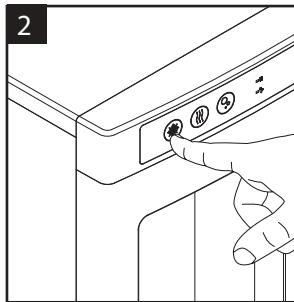

2
Press and hold the cold water button until water comes out.

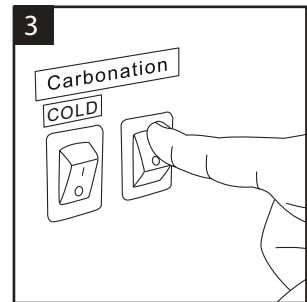

3
On sparkling models turn on the carbonation switch on the back of the unit.

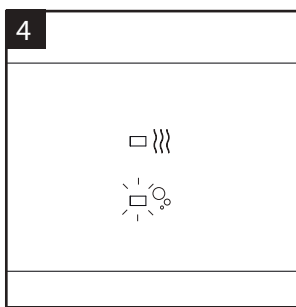

4
The relevant indicator lights will be lit.

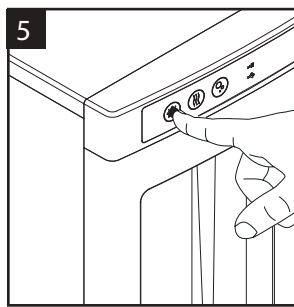

5
All hot & sparkling tanks must be purged of air by holding the corresponding button. Do not switch the hot system on until tank has been purged.

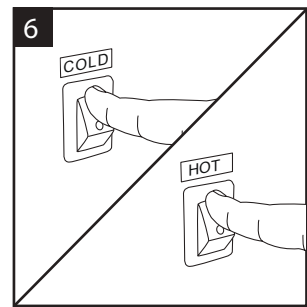

6
To avoid damage do not turn on the cold or hot power switches until water flows out of the machine. (If applicable)

Water Connection & Operation (Continued)

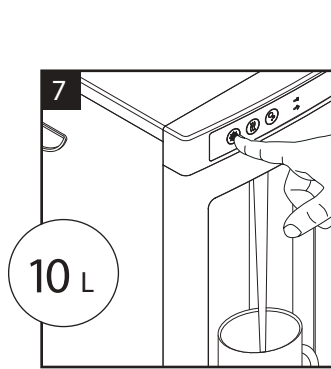

Flush through 10 litres of water before use.

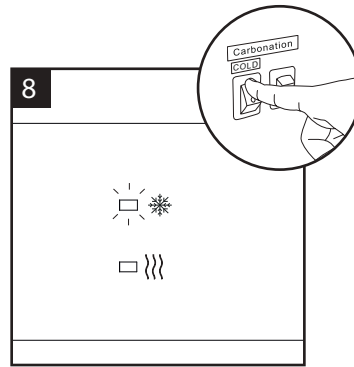

When the cold water switch is turned on, the cold water indicator will be lit.

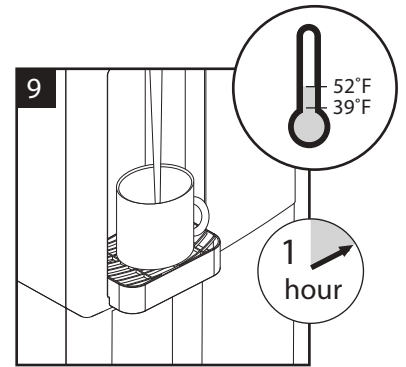

The temperature of cold water can be set from 39°F to 52°F. Allow up to 1 hour for the water to reach its minimum temperature.

CO2 Bottle Installation (Sparkling Versions Only)

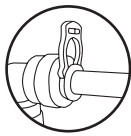

IMPORTANT! ALWAYS ENSURE SECURITY CLIPS ARE USED ON ALL WATER AND CO2 CONNECTIONS.

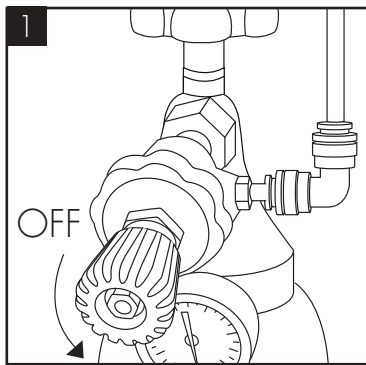

1 Attach the regulator to the disposable CO2 bottle, ensuring the regulator is closed.

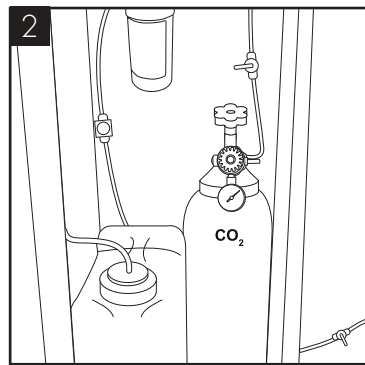

2 Connect the assembled CO2 bottle and regulator to the machine using 1/4 inch pipe.

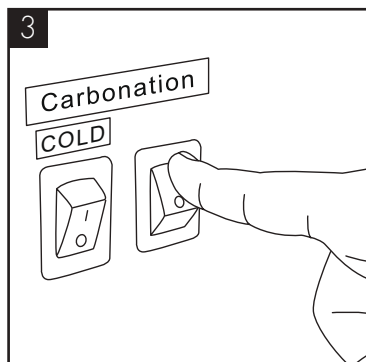

3 After completing the water installation, turn on the sparkling power switch and the pump will run. Do not open the regulator valve until the carbonated switch has been turned on.

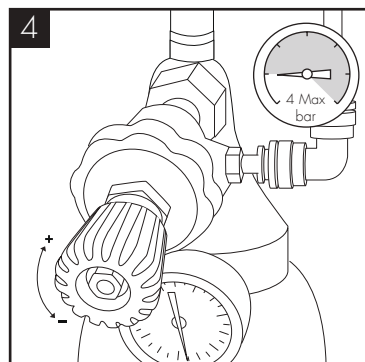

4 We recommend between 3.5 - 4 bar. Do not exceed 4 bar pressure.

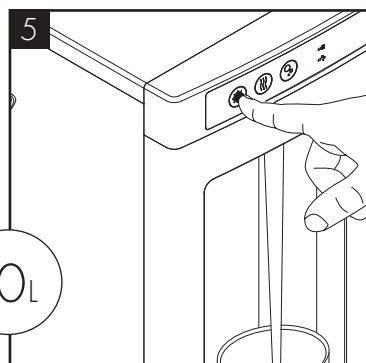

5 Flush through approximately 10 litres of sparkling water. Check and adjust the CO2 pressure accordingly.

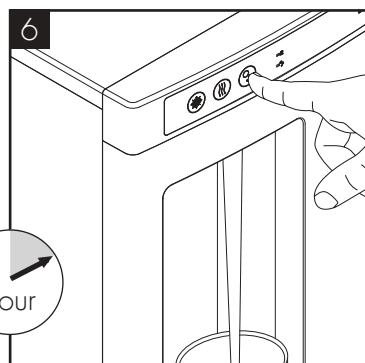

6 Following installation, it will be necessary to leave the machine for up to 1 hour for the initial chilling cycle to occur.

Functions & Controls

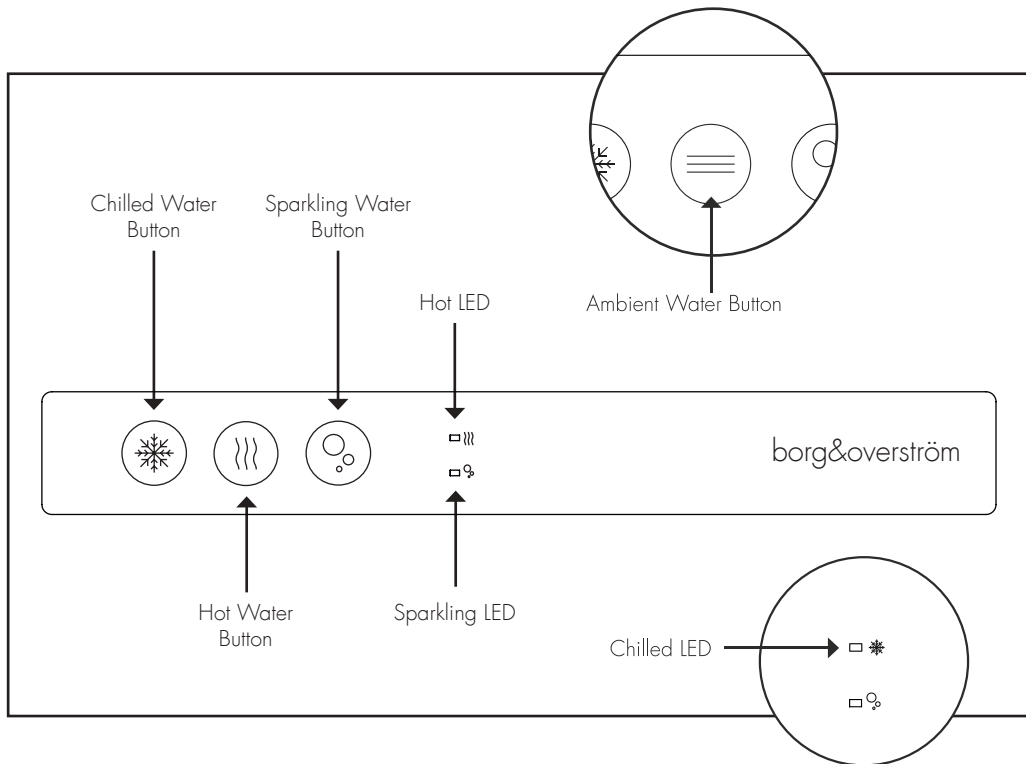

General Safety

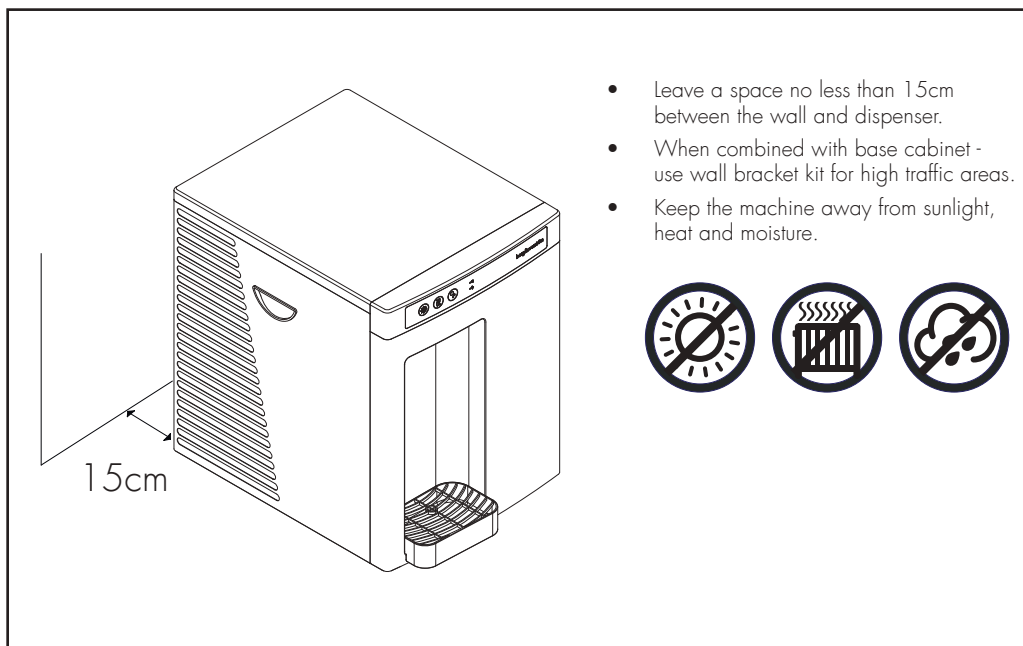

Maintenance

Isolation & Removal

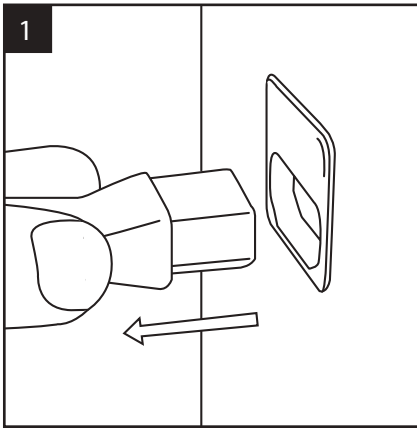

Please make sure the machine is completely disconnected from the electrical supply before carrying out any maintenance work.

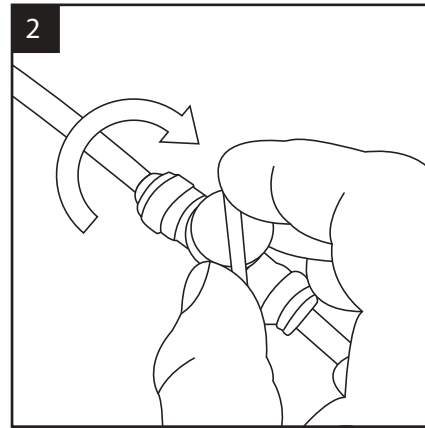

Turn off the water supply.

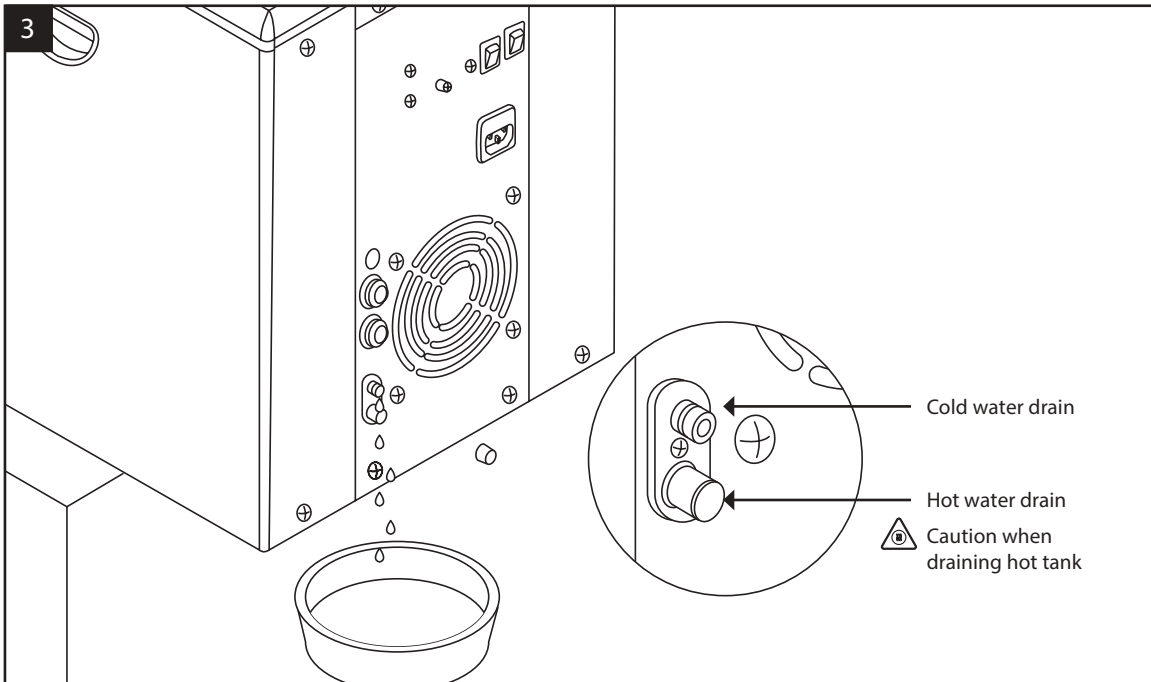

To drain the Direct Chill tank, remove the caps on the back of the machine. We recommend they are re fitted immediately upon draining being completed.

Sanitisation Guide

NOTE: Before beginning the sanitation process please ensure that water is turned off at the mains and refer to the sanitisation liquid MSDS documentation for further information. Use bioguard hand gel and ensure gloves are worn.

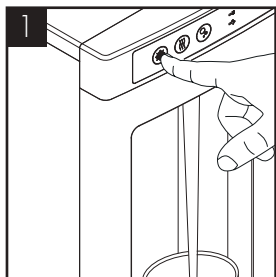

Briefly press cold/ambient dispense buttons to release internal water pressure from the machine.

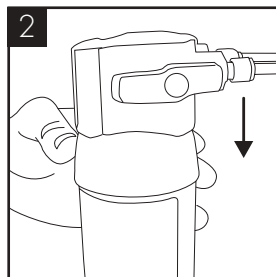

Remove the existing cartridge.



Add 25 ml of Bioguard Internal Sanitisation fluid to a clean and empty service filter cartridge.

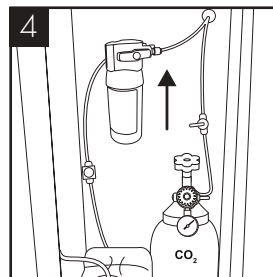

Connect the service cartridge to machine.

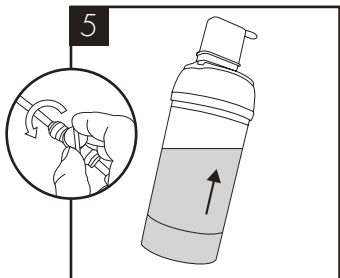

Turn on incoming water, allow service cartridge/doser to fill.

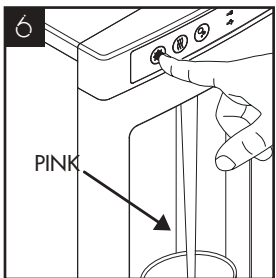

Dispense water using the cold button until the water appears pink. Repeat with sparkling button if present. Briefly press the ambient button too.

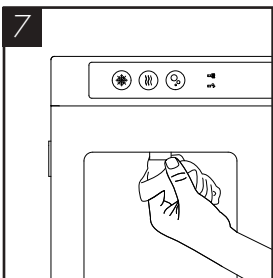

Leave the solution inside machine for sanitisation (minimum 5 minutes) while thoroughly cleaning the machine externally, pay particular attention to the dispense faucet and buttons.

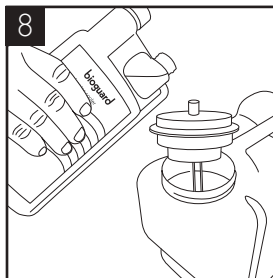

If a Waste Overflow System is fitted, empty this and flush through with a small amount of sanitisation fluid if needed. Remember to include the drip tray and connecting pipe work.

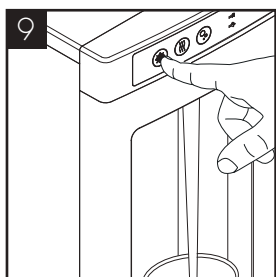

When the external cleaning (after a minimum of 5 minutes) is completed, flush the machine using the cold, sparkling and ambient button with clean water until the dispense water runs clear.

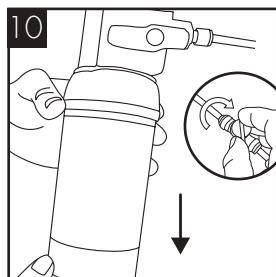

Turn off water and remove the service filter. Retain service filter for reuse.

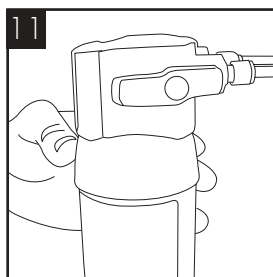

Fit new filter. Turn on incoming water supply.

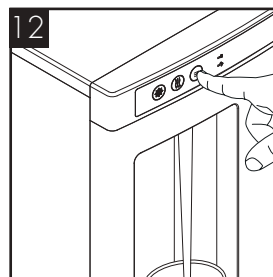

Pre-flush the new filter to waste using the ambient button (and sparkling button if present) until the water appears clear and is free of air. Flush through a small amount of water to check all functions.



Please note that this sanitisation fluid contains an active caustic/alkaline agent. Always use responsibly and with care remembering that due to its alkaline nature unnecessary concentrated/prolonged contact with any materials, including metals, can cause damage. Always rinse all contact surfaces after use with clean water.



Avoid skin contact and wear protective gloves when handling sanitisation fluids



In the event of any skin contact, flush immediately with clean, cold water

Leak Detection (power cut off) - All Variants Enhanced Leak Detection (Flood prevention) Available as Optional Extra.

NOTE: If this machine is equipped with a leak detection device. When leaking is detected the dispense operation will be cut off automatically.

To reset:

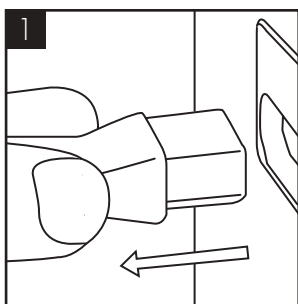

Unplug the machine.

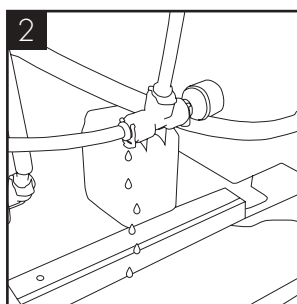

Locate the source of leakage and rectify.

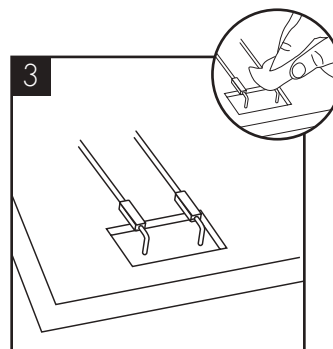

Locate the detection probe which can be found in the bottom rear left hand corner. Dry the probes and internal area with a dry cloth.

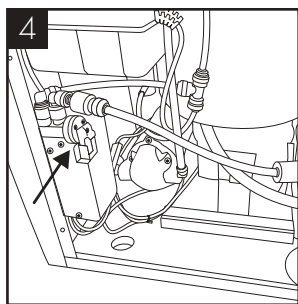

If enhanced Leak Detector is fitted as optional extra: locate the Leak Detector valve.

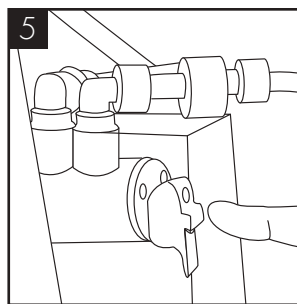

Reset the red lever (push it in).

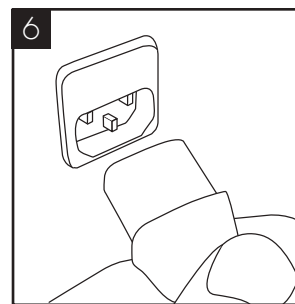

Reconnect the power to machine and test operation.

If leak detector is fitted as optional extra, reset the red lever (push it in)

Emptying the Carbonation Tank for Transportation

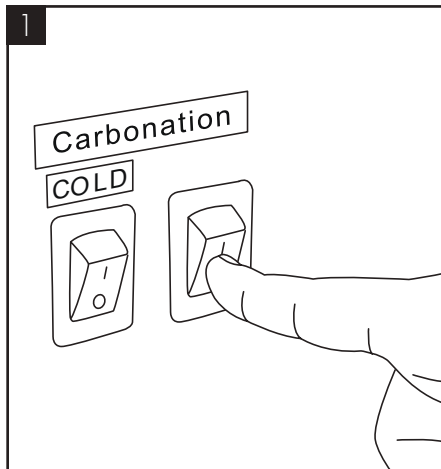

Switch off the Carbonation System switch on the back of the unit.

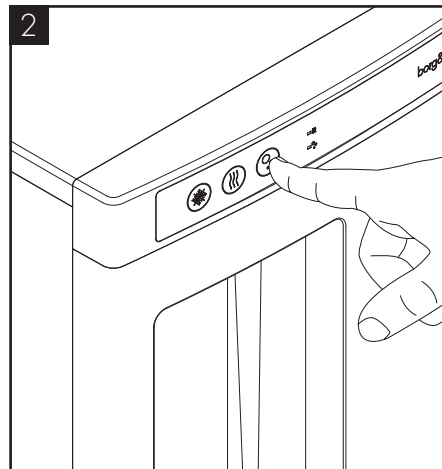

Press and hold the Sparkling water dispense button until all water is expelled.

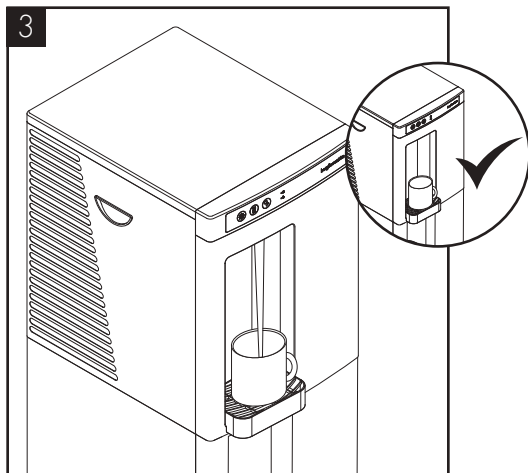

The tank is empty of sparkling water when only CO₂ is being released.

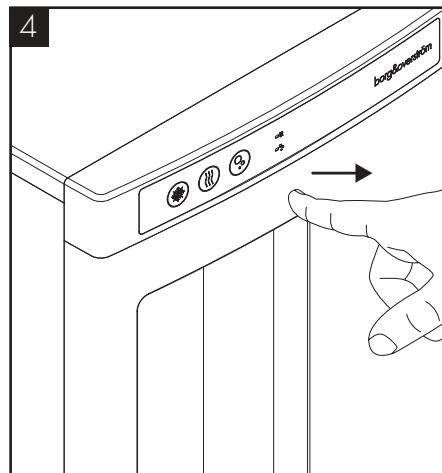

Ensure to release the Sparkling water button and take care to avoid releasing excess amounts of CO₂ gas.

Advanced Troubleshooting

Fault Diagnosis: No Water Dispenses

Problem/Report	Possible Cause	Suggested Action
From Ambient Dispense	Water Supply turned off	Check all that taps/valves/ filters on the incoming supply are fitted and are turned on.
	"Waterblock" tripped off (and tank empty).	Reset "Waterblock" (and check for any leaks).
	"Leak detector" (if fitted) tripped off (and tank empty).	Disconnect the power and water supply, reset the machine (check for leaks).
	Solenoid not working	Dismantle and check the solenoid, completely replacing the solenoid as necessary.
	No Electricity/Power Supply.	Check power cord is connected and live. Check machine is switched on.
	Blocked tank outlets/pipes.	Check and unblock or replace as needed.
	Control PCB not working	Check/replace Control PCB
From Cold Dispense	Firstly all as for Ambient Dispense.	Carry out checks and actions as for ambient dispense.
	Chiller tank frozen – Thermostat set too low.	Thaw out the machine and increase cold water temperature.
	Chiller tank Frozen - Thermostat not working.	Thaw out the machine and check thermostat. Replace Cold Water thermostat as needed.
	Chiller tank frozen.	Circulation pump not working / Thaw out the machine and check circulation pump. Replace circulation pump as needed.

Problem/Report	Possible Cause	Suggested Action
From Hot Dispense	Firstly all as for Ambient Dispense.	Carry out checks and actions as for ambient dispense.
	Airlock in dispense pipe work.	Unblock/replace hot water pipe and hot vent pipe.
	Tank filled with limescale.	Replace tank.
From Sparkling Valve	Firstly as for ambient and cold valve.	Carry out the checks and actions as for cold and ambient.
	Low or no CO ₂ .	Check and replace cylinder as necessary.
	Pump not operating.	Check carbonator level control system.
		Check probes connected/Leads attached. Check power supply to pump.
	Carbonator Tank over pressurised with CO ₂ .	<ol style="list-style-type: none"> 1. Switch the Sparkling System off. 2. Shut off CO₂ supply. 3. Press the Sparkling Water button to release CO₂ from carbonator. 4. Switch the Sparkling system on. 5. Check pump operation is running normally. 6. Wait for the pump to stop running. 7. Re-open CO₂ supply.
	Pump Feed Solenoid Valve.	Check function/condition and repair/replace accordingly.
Carbonation System switched off.	Switch on (Switch on back of the machine).	

Fault Diagnosis: Water Dispenses but not Correct Temperature

Problem/Report	Possible Cause	Suggested Action
Ambient Water too Warm	Low usage and/or heat from compressor influencing stored water.	Check tank insulation and/or advise customer.
	High usage and/or water supply pipe in warm ducting.	Advise customer.
Cold Water not Cold	Cooling switched off.	Check switch positions as necessary.
	Compressor runs and switching off (cool/warm to touch) - Thermostat set too high.	Decrease cold thermostat set point.
	Thermostat not working.	Check/replace thermostat.
	Compressor runs but not switching off (hot to touch).	Please contact technical support.
	Refrigeration problem.	Please contact technical support.
	Compressor not running at all - No electricity power supply.	Check the Power cord is connected and live, and the machine is switched on.
	Compressor only hums slightly/briefly.	Check and replace relays.
	Relays loose.	Check and refit relays.
	Compressor not working.	Please contact technical support.
	Fan not working	Check and replace, as required.
Hot Water not Hot	Hot water mode switched off.	Switch on hot water mode (status LED should show).
	Heating operation tripped off.	Reset overheat button on hot tank.
	Break in supply wiring to control circuit.	Locate break and repair.
	Hot water demand too high.	Advise user/s.
	Heating element not working.	Check and replace Hot tank as required.
	Hot tank heavily scaled (signs of scale in top of tank, loud boiling noises etc).	Carry out thorough descale or replace hot tank.
	Break in supply wiring to main element.	Locate break and repair.

Fault Diagnosis: Water Leaks

Problem/Report	Possible Cause	Suggested Action
Water lying on top edge of lower door panel and/or bottom of Cabinet.	Overflowing Drip Tray waste container.	Empty Waste Container and check drainpipe is not blocked.
Water lying in bottom of machine.	Level Sensors not working.	Check operation/repair/replace as required.
	Leak in supply inlet pipe work and/or filter.	Locate and repair accordingly.
	Leak from machine water pipe work fittings.	Locate and repair accordingly. Check pressure and fit pressure reducing valve if needed.

Fault Diagnosis: Miscellaneous

Problem/Report	Possible Cause	Suggested Action
Repeating beeping noise	Level Sensor fitted and tank full.	Empty Level Sensor tank.
No LED Control Lights	No electricity to Machine.	Check power supply and reconnect as necessary (Also check out other symptoms as described separately).
	Check Fuse in IEC Socket.	Replace if necessary.
	Control PCB not working (Machine working normally otherwise).	Check/replace PCB.
Machine Shakes on Start-up	Compressor Starting.	No action needed. This is quite normal.
	Level Surface.	
	Uneven Surface.	Level up machine using adjustable feet.
	Missing Fixings.	Replace missing fixings.
Tripping out Electricity Supply	Machine in high humidity environment.	Discuss possible repositioning with customer.
	Electrical circuitry faults.	Test, identify and address accordingly. See Electrical Diagrams.
		Please contact technical support

Fault Diagnosis: Miscellaneous

Problem/Report	Possible Cause	Suggested Action
Slow but Continuous Water Dispense from Ambient or Cold Tap	Low incoming water pressure	Consider replumbing to alternative supply if possible
		Fit Booster pump set.
Intermittent Water Dispense from Ambient or Cold Water Valve	Trapped air in pipework (especially where water pressure is low after filter change).	Hold button on to purge air out (This could take several minutes where pressure is low).
		Pre-flush filters
	Button not being pressed enough	Press button firmly. Could be caused by surrounding cold environment making the button stiffer.
	Faulty PCB	Replace PCB
Intermittent Water Dispense from Ambient or Cold Water Valve and hammering noise.	Fluctuating mains water pressure situation.	Please contact technical support.
Continuous Water Dispense from Ambient/Cold or Hot water valve.	Button jammed on/faulty.	Replace PCB or/button panel as needed.
	Debris blocking hole in diaphragm window.	Dismantle valve and clean out.

Chilled, Ambient & Hot

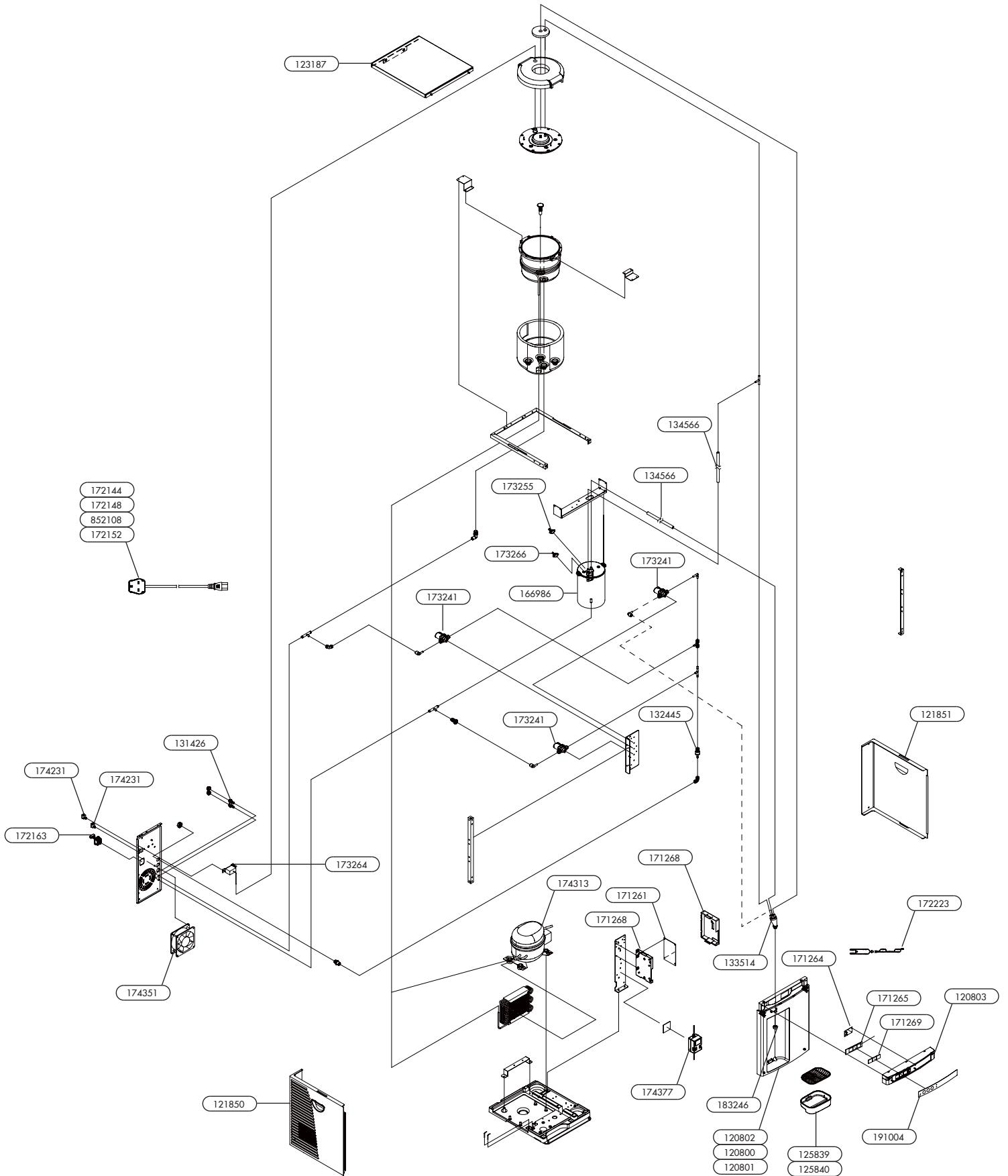

- 172144
- 172148
- 852108
- 172152

- 174231
- 174231
- 172163
- 131426
- 174351
- 173264

- 121850

- 120802
- 120800
- 120801
- 125839
- 125840

Chilled, Ambient & Sparkling

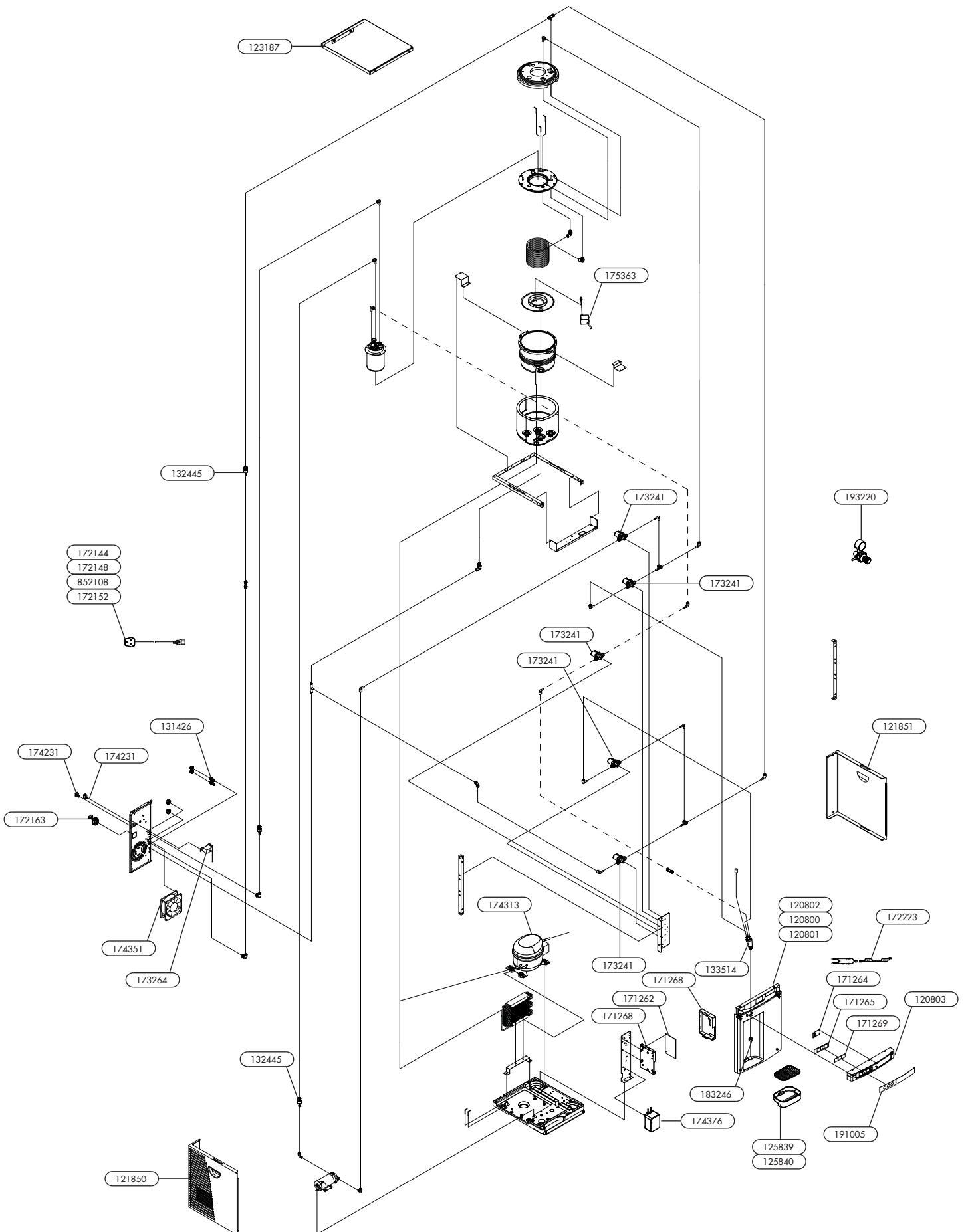

Chilled, Hot & Sparkling

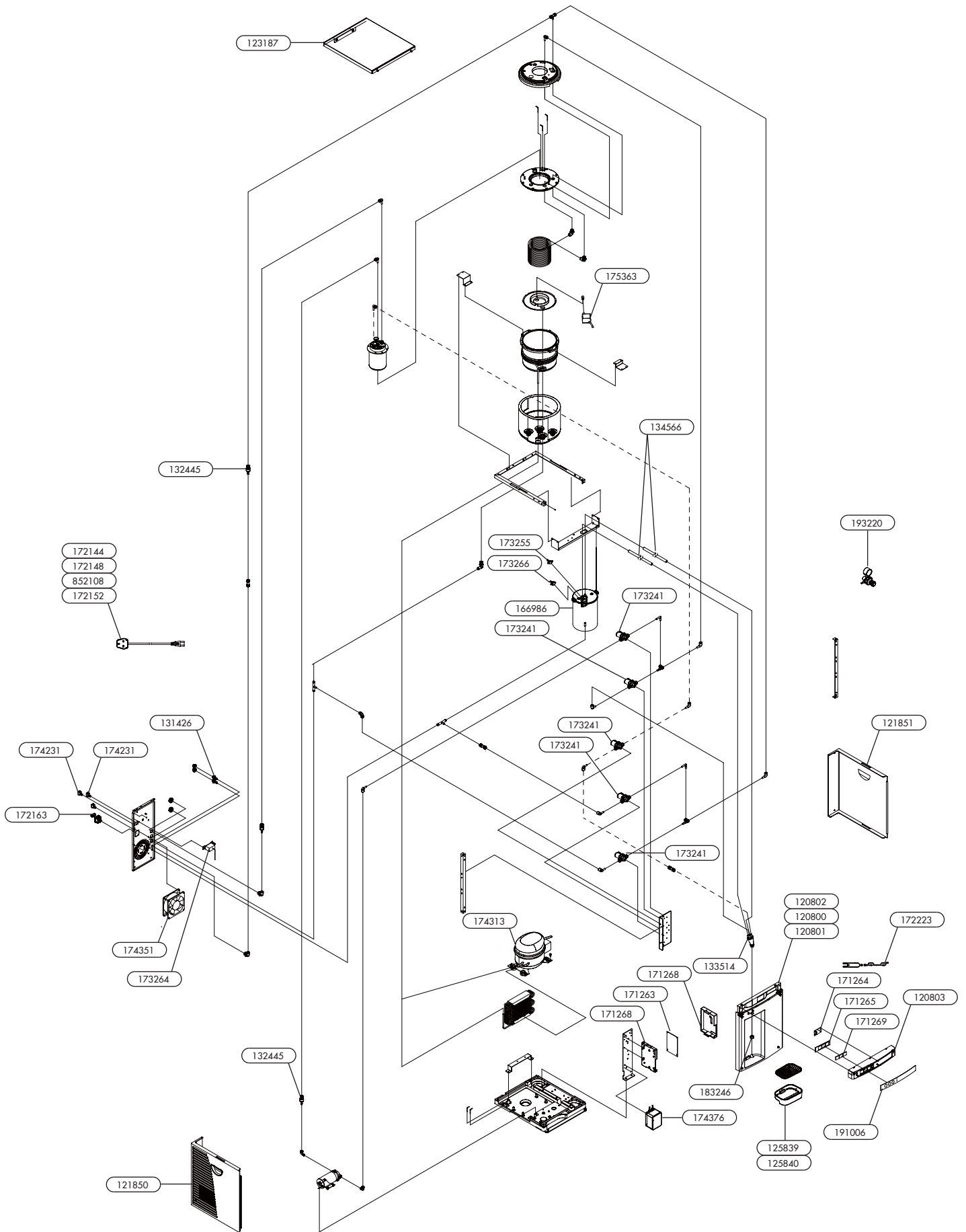

Base Unit Exploded Diagram

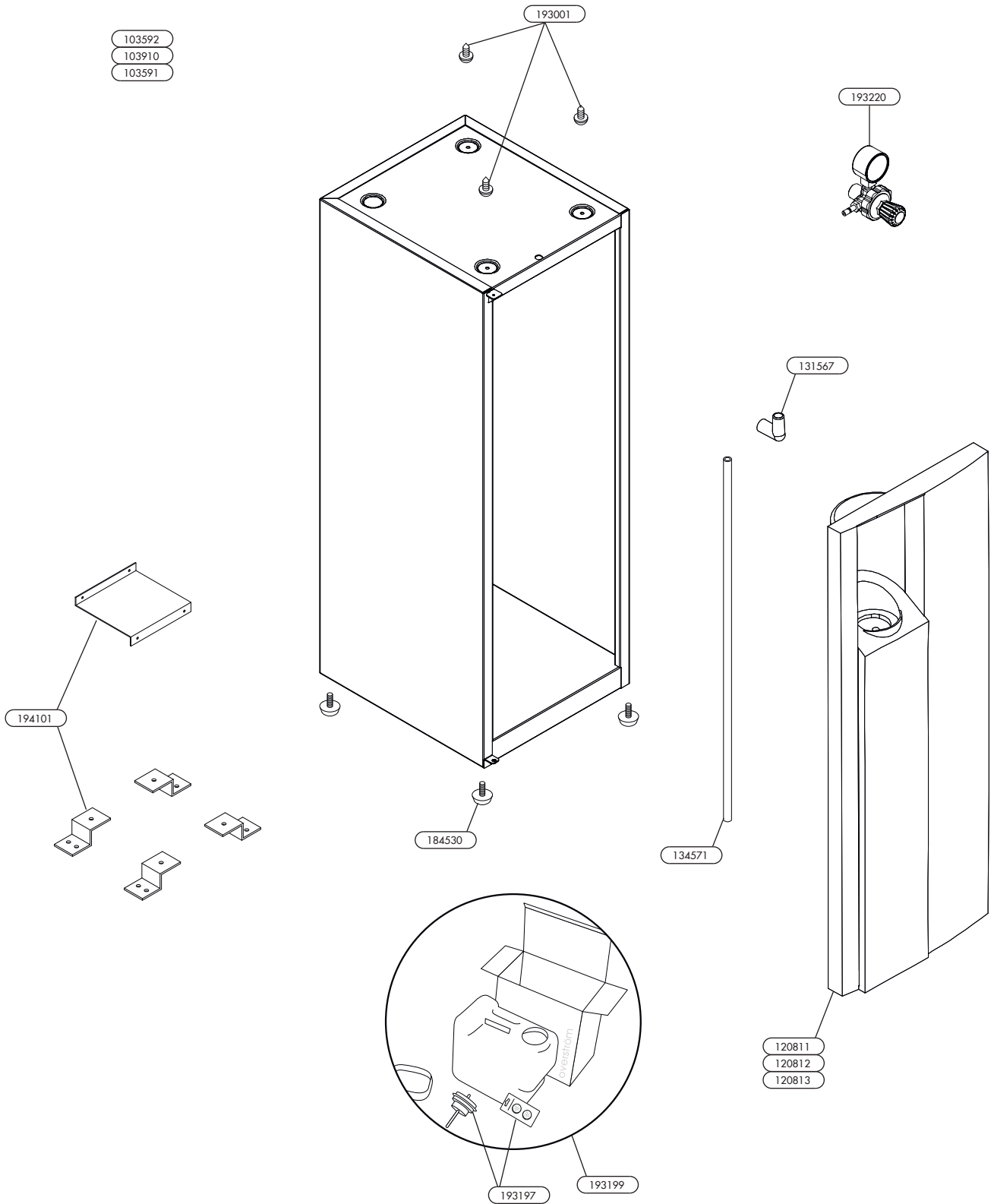

Parts List













Borg & Overstrom Part No	Description	Recommended Engineers Spares
103591	Complete B4 Base Cabinet Assembly (Floorstanding) - White	
103592	Complete B4 Base Cabinet Assembly (Floorstanding) - Black	
103910	Complete B4 Base Cabinet Assembly (Floorstanding) - Silver	
120800	B4.2 Front Panel - Silver	
120801	B4.2 Front Panel - White	
120802	B4.2 Front Panel - Black	
120803	B4.2 Upper Front Panel	
120811	B4.2 Cabinet Door Panel Assembly - Silver	
120812	B4.2 Cabinet Door Panel Assembly - White	
120813	B4.2 Cabinet Door Panel Assembly - Black	
121581	B4 Right Side Panel inc handle	
121850	B4 Left Side Panel inc handle	
121851	B4 Right Side Panel inc handle	
123187	Top Cover Panel	
125839	B4.2 Drip Tray Set with drainage - Black	
125840	B4.2 Drip Tray Set without drainage - Black	
131426	2-Port Drainage Outlet	
131567	Waste Connection Elbow	
132445	Single Check Valve	*
133514	Faucet 4 outlets	*
134566	Straight Type Silicon Tube	
134571	B4 Base Cabinet Drainage Tube 780mm	
166986	Hot Tank	*
171260	B3.2/B4.2 Chilled & Ambient Main PCB	*
171261	B3.2/B4.2 Chilled, Ambient & Hot Main PCB	*
171262	B3.2/B4.2 Chilled, Ambient & Sparkling Main PCB	*
171263	B3.2/B4.2 Chilled, Hot & Sparkling Main PCB	*
171264	B3.2/B4.2 LED Display PCB	*
171265	Touch Panel PCB Board	*
171268	B3.2/B4.2 Main PCB Case Assembly	
171269	B3.2/B4.2 Touch Icon Illumination Diffuser	*
172144	Power Cord Set - Danish	
172148	Power Cord Set - Schuko/EURO	
172152	Power Cord Set - UK	
172163	IEC Fused Socket	*
172223	B3.2/B4.2 LED PCB Wiring Loom	*
173241	HP1/4PFx1/4PFS24 Solenoid Valve	*
173255	105° Hot Tank Over-heat cut out	*
173264	Cold Temperature Thermostat	*
173266	92° Hot Tank Thermostat Sensor	*
174231	Electric Rocker Switch	*
174313	Compressor	
174351	Cooling Fan	*
174376	Carbonation Pump Transformer	*
174377	Transformer 24VDC	*
175363	Circular DC Circulation Pump	*

Parts List

Borg & Overstrom Part No	Description	Recommended Engineers Spares
183246	Chrome B3.2/B4.2 Faucet Shroud	*
184530	Base Cabinet Replacement Foot Set	*
191003	B4.2 Chilled & Ambient Touch Control Panel	*
191004	B4.2 Chilled, Ambient & Hot Touch Control Panel	*
191005	B4.2 Chilled, Ambient & Sparkling Touch Control Panel	*
191006	B4.2 Chilled, Hot & Sparkling Touch Control Panel	*
193001	B4 Floorstanding Interconnection Kit	
193197	Waste Alarm Module (inc Batteries)	
193199	B4.2 Level Sensor Kit (inc Waste Container)	
193220	CO2 Regulator with gauge c/w elbow	*
194101	Wall and Floor Bracket Kit	
852108	Power Cord Set - Swiss	

Technical Information







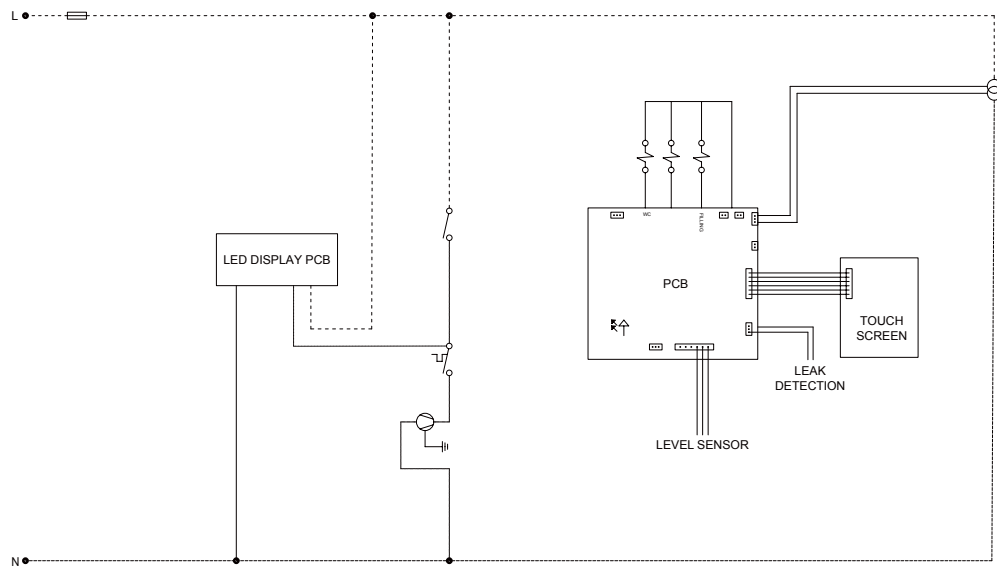





Chilled & Ambient Electrical Circuit Diagram

KEY	
	CONDENSER FAN
	TEMPERATURE PROBE
	FAN
	COMPRESSOR
	TRANSFORMER
	SWITCH
	SOLENOID
	FUSE
	PUMP
	BRIDGE DIODE
	TEMPERATURE SWITCH
	HOT WATER TANK
	LED

	BLACK
	PURPLE
	BROWN
	BLUE
	WHITE
	YELLOW
	ORANGE
	RED







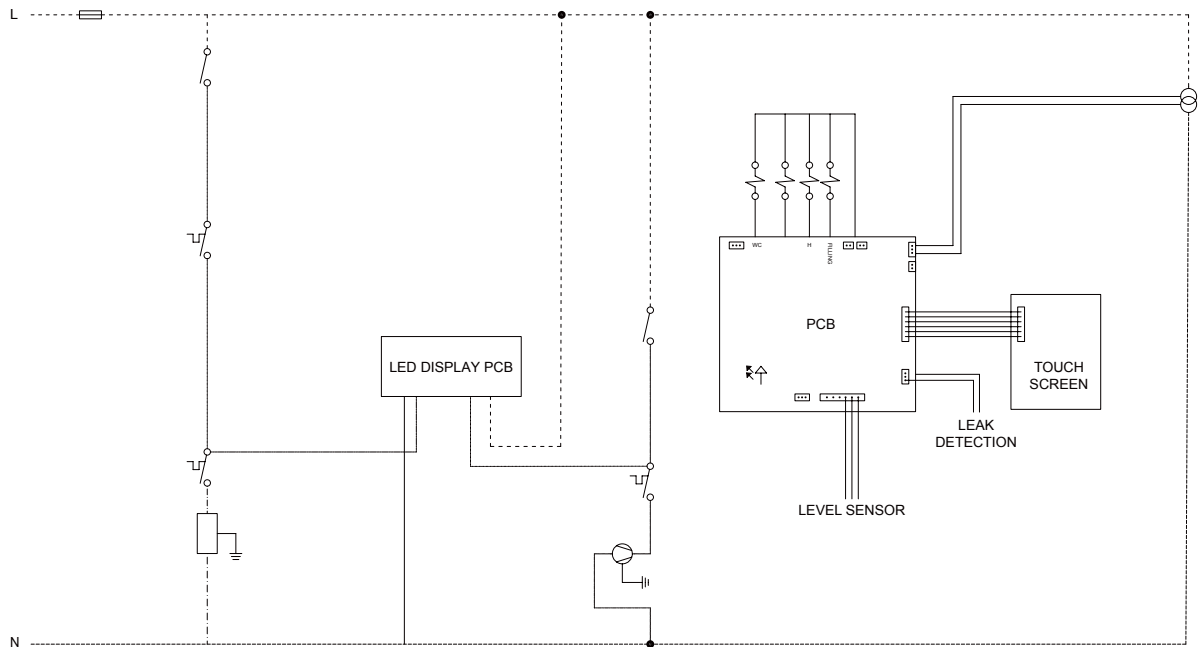













Chilled, Ambient & Hot Electrical Circuit Diagram

KEY		——	BLACK
	CONDENSER FAN	- - - -	PURPLE
	TEMPERATURE PROBE	· · · ·	BROWN
	FAN	——	BLUE
	COMPRESSOR	——	WHITE
	TRANSFORMER	- - - -	YELLOW
	SWITCH	——	ORANGE
	SOLENOID	——	RED
	FUSE		
	PUMP		
	BRIDGE DIODE		
	TEMPERATURE SWITCH		
	HOT WATER TANK		
	LED		



Chilled, Ambient & Sparkling Electrical Circuit Diagram





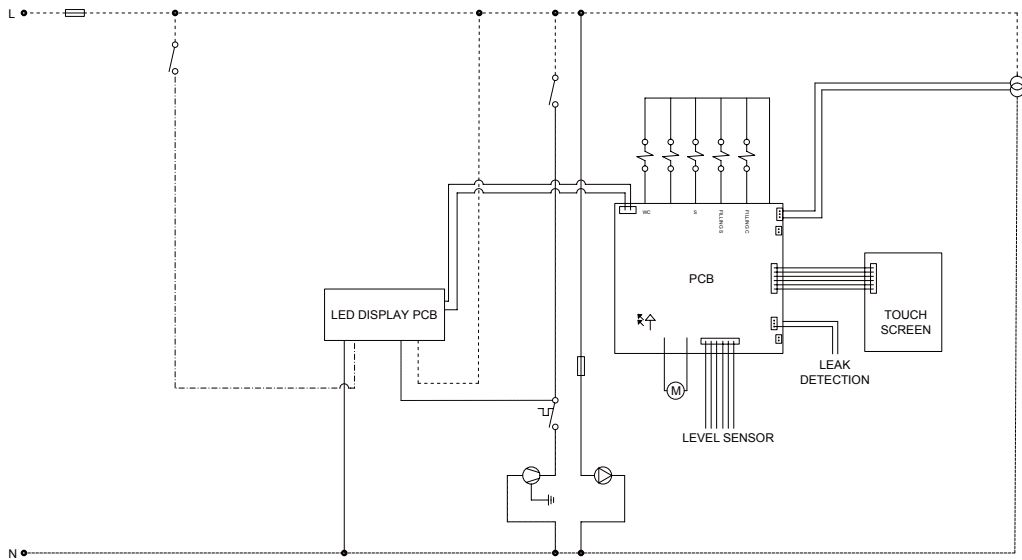

















KEY	
	CONDENSER FAN
	TEMPERATURE PROBE
	FAN
	COMPRESSOR
	TRANSFORMER
	SWITCH
	SOLENOID
	FUSE
	PUMP
	BRIDGE DIODE
	TEMPERATURE SWITCH
	HOT WATER TANK
	LED
	OTOR

	BLACK
	PURPLE
	BROWN
	BLUE
	WHITE
	YELLOW
	ORANGE
	RED



Chilled, Hot & Sparkling Electrical Circuit Diagram

KEY

	CONDENSER FAN		BLACK
	TEMPERATURE PROBE		PURPLE
	FAN		BROWN
	COMPRESSOR		BLUE
	TRANSFORMER		WHITE
	SWITCH		YELLOW
	SOLENOID		ORANGE
	FUSE		RED
	PUMP		
	BRIDGE DIODE		
	TEMPERATURE SWITCH		
	HOT WATER TANK		
	LED		
	OTOR		

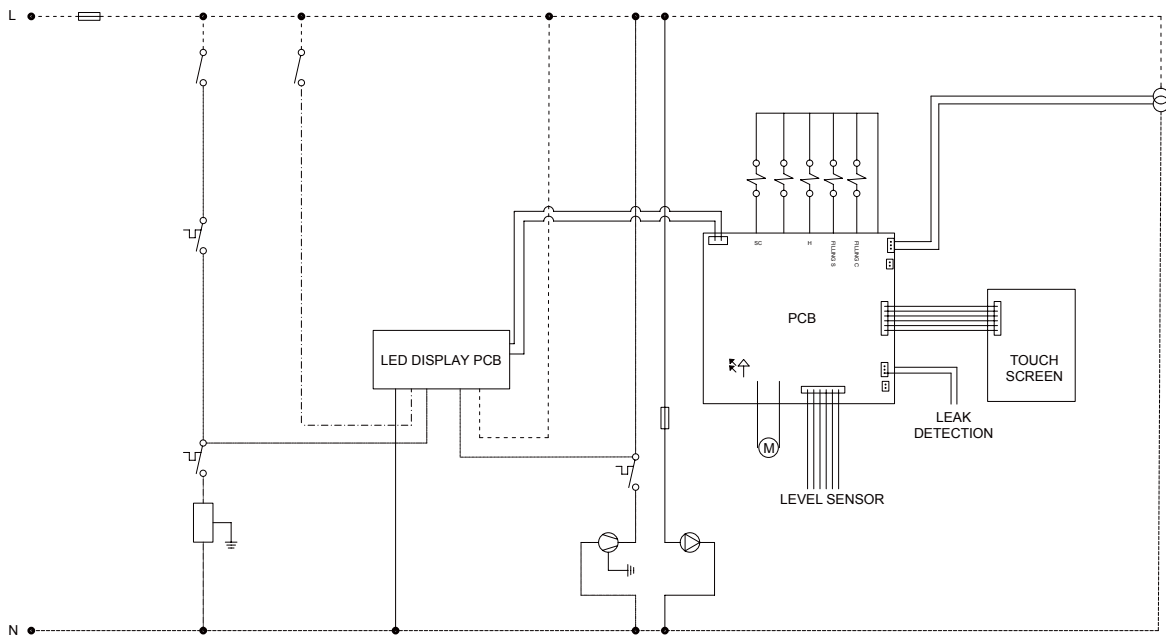

Chilled & Ambient Water Pathway Diagram

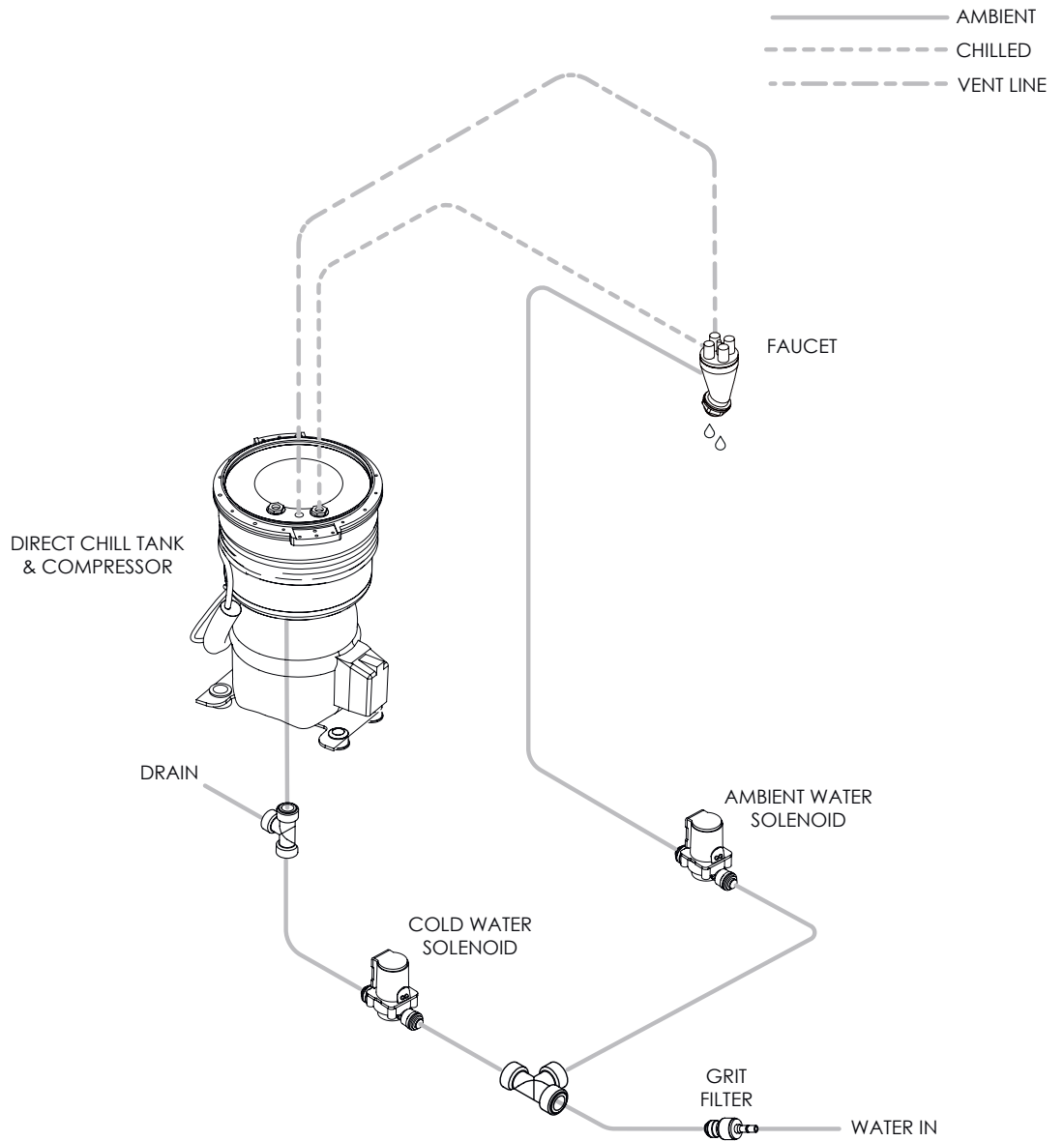

Chilled, Ambient & Hot Water Pathway Diagram

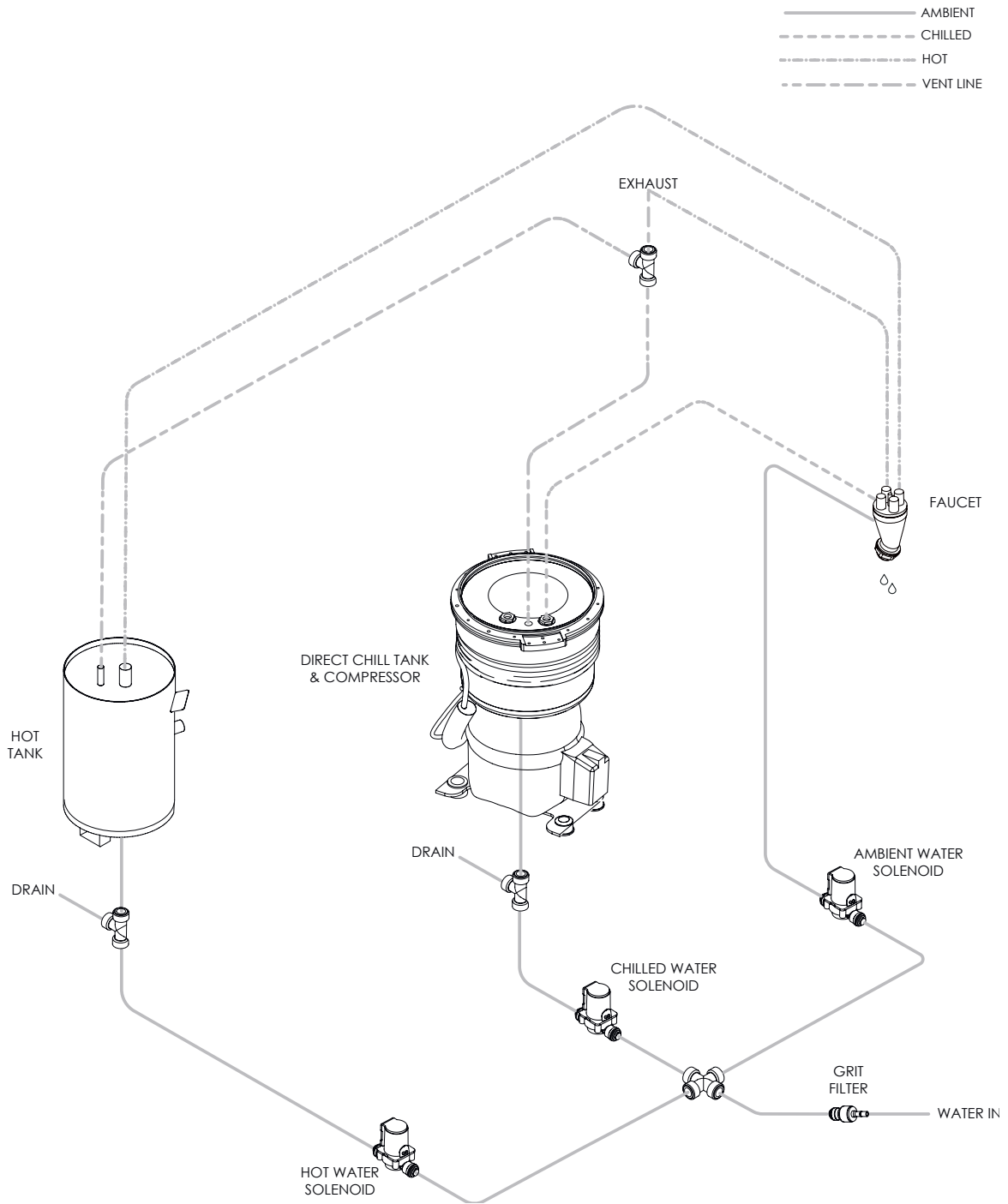

Chilled, Ambient & Sparkling Water Pathway Diagram

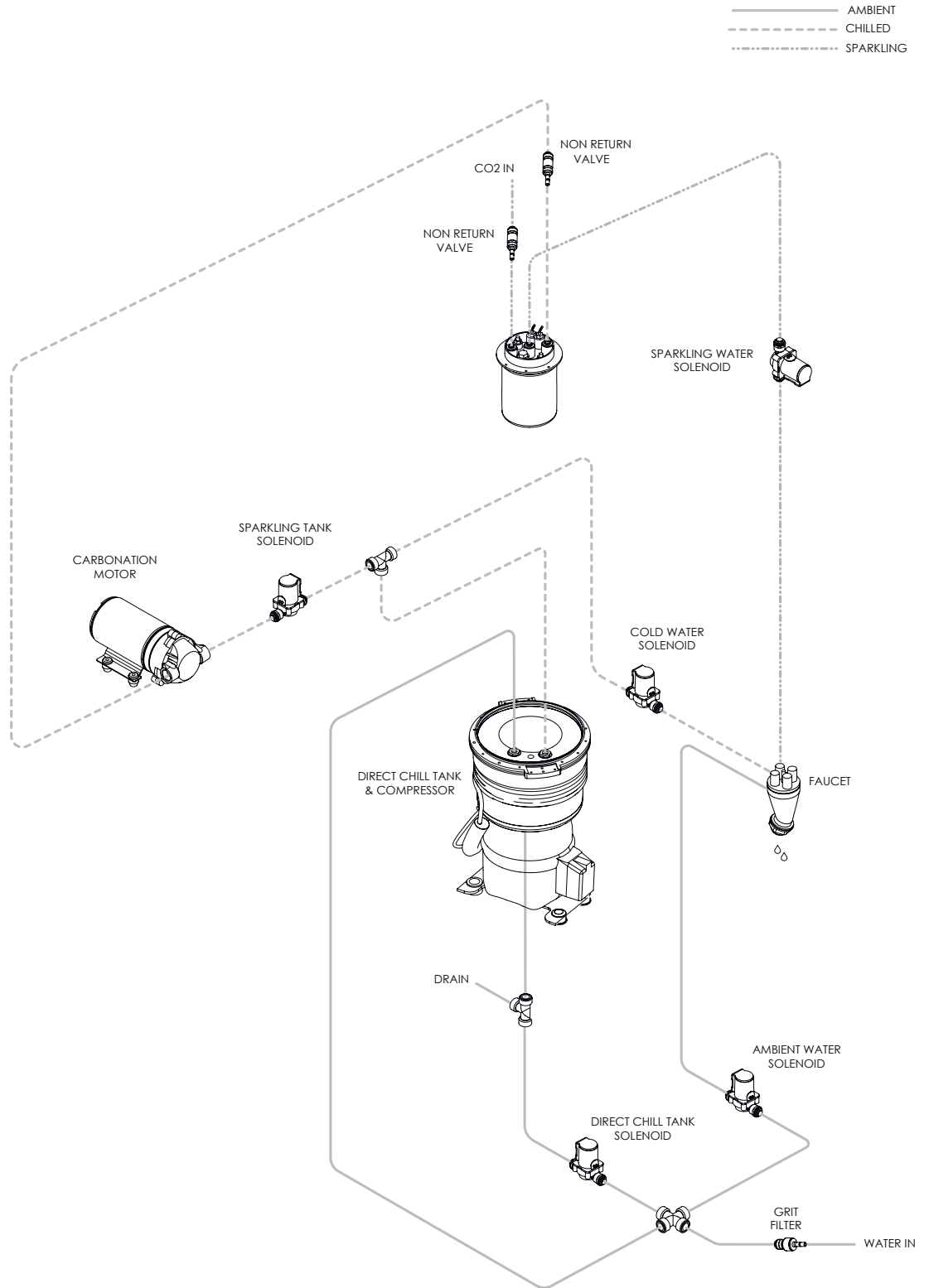

Chilled, Hot & Sparkling Water Pathway Diagram

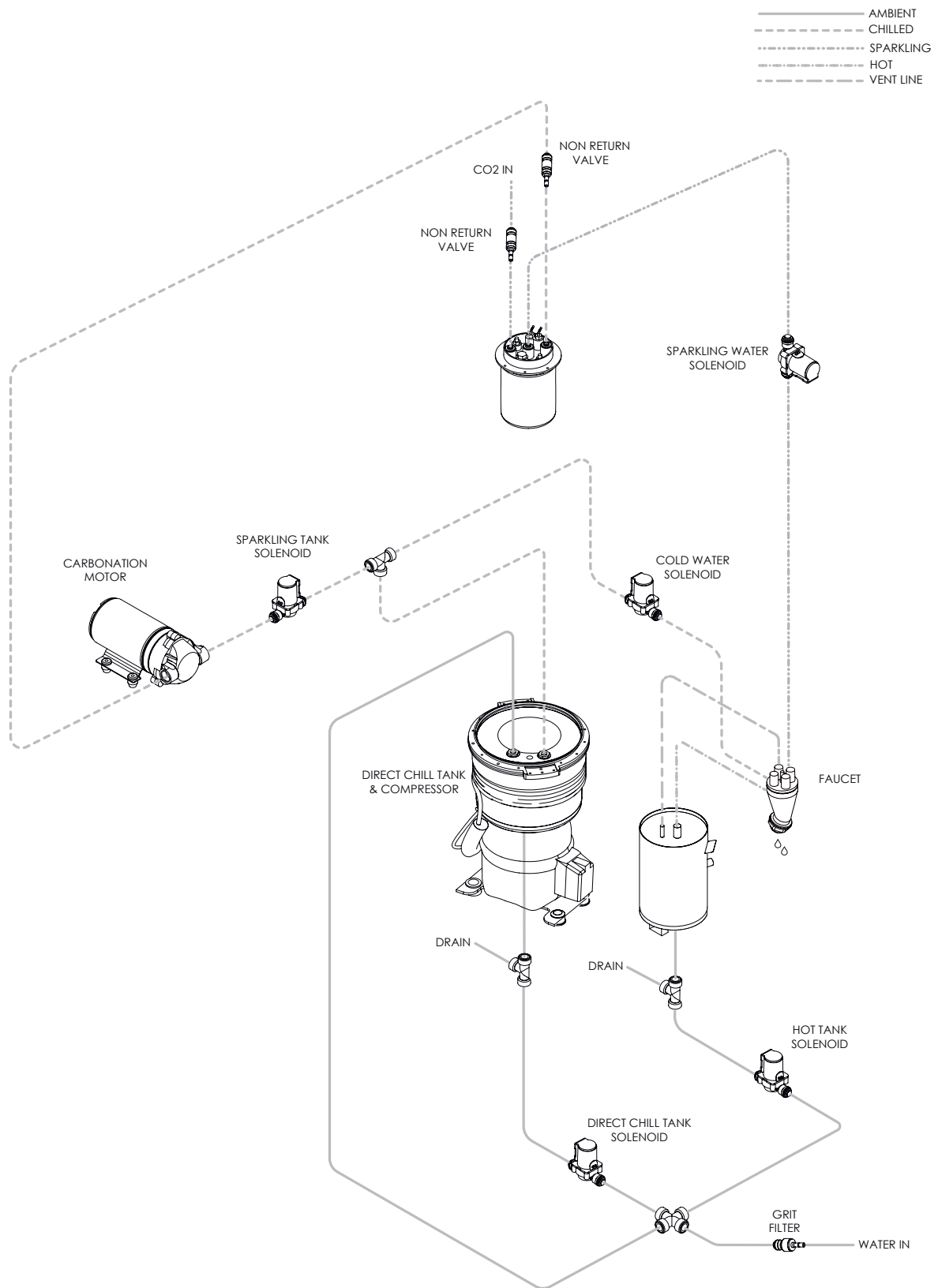

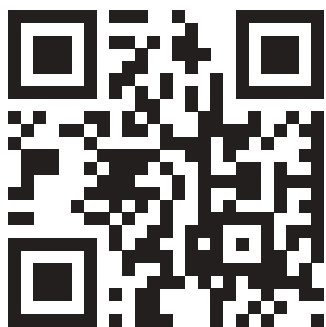

Customer services:

Email: rmiller@youraquaessentials.com

Call: 1 (615) 942-7867

Fax: 1 (615) 345-0500

Telephone
(615) 942-7867
Email
rmiller@youraquaessentials.com

Aqua Essentials
1416 Antioch Pike, Suite 103
Nashville, TN 37013

www.youraquaessentials.com

Verson : 121718 - 01